

Approval body for construction products
and types of construction

Bautechnisches Prüfamt

An institution established by the Federal and
Laender Governments



European Technical Assessment

ETA-18/0680
of 10 September 2018

English translation prepared by DIBt - Original version in German language

General Part

Technical Assessment Body issuing the
European Technical Assessment:

Deutsches Institut für Bautechnik

Trade name of the construction product

JT2-D-6-5/6,3xL, JT2-D-12-5/6,3xL, JT2-D-18-5/6,3xL,
JT2-D-2-6,5/7,0xL,

Product family
to which the construction product belongs

Fastening screws for sandwich elements on steel and
wooden structures

Manufacturer

EJOT Baubefestigungen GmbH
In der Stockwiese 35
57334 Bad Laasphe
DEUTSCHLAND

Manufacturing plant

manufacturing plant 8, 12, 19 and 21

This European Technical Assessment
contains

19 pages including 15 annexes which form an integral
part of this assessment

This European Technical Assessment is
issued in accordance with Regulation (EU)
No 305/2011, on the basis of

EAD 330047-01-0602

The European Technical Assessment is issued by the Technical Assessment Body in its official language. Translations of this European Technical Assessment in other languages shall fully correspond to the original issued document and shall be identified as such.

Communication of this European Technical Assessment, including transmission by electronic means, shall be in full. However, partial reproduction may only be made with the written consent of the issuing Technical Assessment Body. Any partial reproduction shall be identified as such.

This European Technical Assessment may be withdrawn by the issuing Technical Assessment Body, in particular pursuant to information by the Commission in accordance with Article 25(3) of Regulation (EU) No 305/2011.

Specific part

1 Technical description of the product

The fastening screws are self-drilling or self-tapping screws made of austenitic stainless steel or carbon steel with anticorrosion coating (listed in Table 1). The fastening screws are completed with sealing washers consisting of metal washer and EPDM-seal.

Table 1 – Fastening screws for sandwich panels

Annex	Fastening screw	Component I	Component II
4	JT2-D-6H-5,5/6,3xL	S280GD to S350GD	S235 to S355 S280GD to S450GD HX300LAD to HX460LAD
5	JT2-D-6H-5,5/6,3xL	S280GD to S350GD	S235 to S355 S280GD to S450GD HX300LAD to HX460LAD
6	JT2-D-6H-5,5/6,3xL	S280GD to S350GD	S235 to S355 S280GD to S450GD HX300LAD to HX460LAD
7	JT2-D-12H-5,5/6,3xL	S280GD to S350GD	S235 to S355 S280GD to S350GD
8	JT2-D-12H-5,5/6,3xL	S280GD to S350GD	S235 to S355 S280GD to S350GD
9	JT2-D-12H-5,5/6,3xL	S280GD to S350GD	S235 to S355 S280GD to S350GD
10	JT2-D-18H-5,5/6,3xL	S280GD to S350GD	S235 to S355 S280GD to S350GD
11	JT2-D-18H-5,5/6,3xL	S280GD to S350GD	S235 to S355 S280GD to S350GD
12	JT2-D-18H-5,5/6,3xL	S280GD to S350GD	S235 to S355 S280GD to S350GD
13	JT2-D-2H-6,5/7,0xL	S280GD to S350GD	Timber
14	JT2-D-2H-6,5/7,0xL	S280GD to S350GD	Timber
15	JT2-D-2H-6,5/7,0xL	S280GD to S350GD	Timber

2 Specification of the intended use in accordance with the applicable European Assessment Document

The fastening screws are intended to be used for fastening sandwich panels to metal or timber substructures. The sandwich panel can either be used as wall or roof cladding or as load bearing wall and roof element. The intended use comprises fastening screws and connections for indoor and outdoor applications. Fastening screws which are intended to be used in external environments with \geq C2 corrosion according to the standard EN ISO 12944-2 are made of

stainless steel. Furthermore the intended use comprises connections with predominantly static loads (e.g. wind loads, dead loads). The fastening screws are not intended for re-use.

The performances given in Section 3 are only valid if the fastening screws are used in compliance with the specifications and conditions given in Annexes (1-15).

The verification and assessment methods on which this European Technical Assessment is based lead to the assumption of a working life of the fastening screws of at least 25 years. The indications given on the working life cannot be interpreted as a guarantee given by the manufacturer, but are to be regarded only as a means for choosing the right products in relation to the expected economically reasonable working life of the works.

3 Performance of the product and references to the methods used for its assessment

3.1 Mechanical resistance and stability (BWR 1)

Essential characteristic	Performance
Shear Resistance of the Connection	see Annexes to this ETA
Tension Resistance of the Connection	see Annexes to this ETA
Design Resistance in case of combined Tension and Shear Forces (interaction)	see Annexes to this ETA
Check of Bending Capacity in case of constraining forces due to temperature	see Annexes to this ETA
Durability	No performance assessed

3.2 Safety in case of fire (BWR 2)

Essential characteristic	Performance
Reaction to fire	Performance Class A1

4 Assessment and verification of constancy of performance (AVCP) system applied, with reference to its legal base

In accordance with EAD No. 330047-01-0602, the applicable European legal act is: Commission Decision 1998/214/EC, amended by 2001/596/EC.

The system to be applied is: 2+

5 Technical details necessary for the implementation of the AVCP system, as provided for in the applicable EAD

Technical details necessary for the implementation of the AVCP system are laid down in the control plan deposited at Deutsches Institut für Bautechnik.

Issued in Berlin on 10 September 2018 by Deutsches Institut für Bautechnik

BD Dipl.-Ing. Andreas Kummerow
Head of Department

beglaubigt:
Schult

Examples of execution and connection

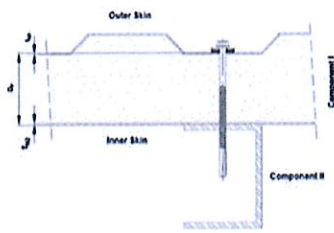

Component II made of metal

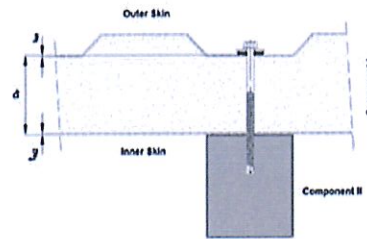

Component II made of timber

Materials and dimensions

Design relevant materials and dimensions are indicated in the Annexes of the fastening screws:

Fastener	Material of the fastening screw
Washer	Material of the sealing washer
Component I	Material of the sandwich panel (outer skin and inner skin)
Component II	Material of substructure

D_f	Thickness of component I
t_{N1}	Thickness of the outer skin of component I
t_{N2}	Thickness of the inner skin of component I
$t_{N,II}$	Thickness of component II made of metal
l_{ef}	Effective screw-in length in component II made of timber (without drill point)
l_g	Screw-in length in component II made of timber (with drill point)
d_{pd}	Pre-drill diameter of component I and II

The thickness $t_{N,II}$ corresponds to the load-bearing screw-in length of the fastening screw in component II, if the load-bearing screw-in length does not cover the entire component thickness.

Performance characteristics

The design relevant performance characteristics of a connection are indicated in the Annexes of the fastening screws:

$N_{R,k}$	Characteristic value of tension resistance
$V_{R,k}$	Characteristic value of shear resistance
u	Maximum allowed head displacement of the fastening screw

In some cases component-specific performance characteristics are indicated for an individual calculation of the design relevant performance characteristics of a connection:

$N_{R,I,k}$	Characteristic value of pull-through resistance for the outer skin of component I
$N_{R,II,k}$	Characteristic value of pull-out resistance for component II
$V_{R,I,k}$	Characteristic value of hole bearing resistance for the inner skin of component I
$V_{R,II,k}$	Characteristic value of hole bearing resistance for component II
$M_{y,Rk}$	Characteristic value of yield moment of the fastening screw for component II made of timber
$f_{ax,k}$	Characteristic value of withdrawal strength for component II made of timber
$f_{h,k}$	Characteristic value of embedding strength for component II made of timber

Terms and explanations

Fastening screws for sandwich panels

Annex 1

Occurred loadings of a connection

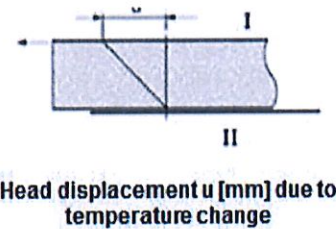
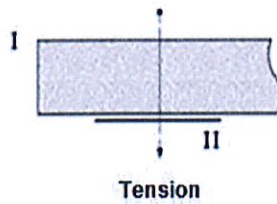
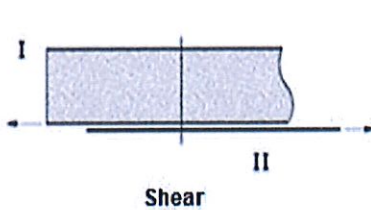

Design values

The design values of tension and shear resistance of a connection have to be determined as following:

$N_{R,d}$	Design value of tension resistance
$V_{R,d}$	Design value of shear resistance
γ_M	Partial safety factor

The recommended partial safety factor γ_M is 1,33, provided no partial safety factor is given in national regulations or national Annexes to Eurocode 3.

Special conditions

If the component thickness t_{N1} , t_{N2} or $t_{N,II}$ lies in between two indicated component thicknesses, the characteristic value may be calculated by linear interpolation.

For asymmetric components II made of metal (e.g. Z- or C-shaped profiles) with component thickness $t_{N,II} < 5$ mm, the characteristic value $N_{R,k}$ has to be reduced to 70%.

In case of combined loading by tension and shear forces the following interaction equation has to be taken into account:

$$\frac{N_{S,d}}{N_{R,d}} + \frac{V_{S,d}}{V_{R,d}} \leq 1,0$$

$N_{S,d}$	Design value of the applied tension forces
$V_{S,d}$	Design value of the applied shear forces

Head displacement

The head displacement of the fastening screw as a result of thermal expansion of the outer skin of the sandwich panel may not exceed the maximum allowed head displacement of the fastening screw.

Installation conditions

The installation is carried out according to manufacturer's instruction.

The load-bearing screw-in length of the fastening screw specified by the manufacturer has to be taken into account.

The fastening screws have to be processed with suitable drill driver (e.g. cordless drill driver with depth control). The use of impact wrench is not allowed.

The fastening screws have to be fixed rectangular to the surface of the component.

Component I and component II have to be in direct contact to each other. The use of compression resistant thermal insulation strips up to a thickness of 3 mm is allowed.

Design and installation

Fastening screws for sandwich panels

Annex 2

Component II made of timber

The characteristic values of tension and shear resistance:

$$N_{R,k} = \min \left\{ \begin{array}{l} N_{R,I,k} \\ N_{R,II,k} * k_{mod} \end{array} \right. \quad V_{R,k} = \min \left\{ \begin{array}{l} V_{R,I,k} \\ V_{R,II,k} * k_{mod} \end{array} \right.$$

$N_{R,I,k}$ and $V_{R,I,k}$ are given in the Annex of the fastening screw.

$N_{R,II,k}$ is determined according to EN 1995-1-1:2014 + A1:2008, equation (8.40a), with $f_{axi,k}$ given in the Annex of the fastening screw.

$V_{R,II,k}$ is determined according to EN 1995-1-1:2004 + A1:2008, equation (8.9), with $M_{y,Rk}$ given in the Annex of the fastening screw and $f_{h,k}$ according to EN 1995-1-1:2014 + A1:2008, equation (8.15) and equation (8.16).

Additional provisions

Fastening screws for sandwich panels

Annex 3

	Materials: Fastener: carbon steel case hardened and corrosion-resistant Washer: carbon steel, corrosion-resistant with vulcanised EPDM seal stainless steel (A2/A4) – EN ISO 3506 with vulcanised EPDM seal Component I: S280GD to S350GD – EN 10346 Component II: S235 to S355 – EN 10025-1 S280GD to S450GD – EN 10346 HX300LAD to HX460LAD – EN 10346
	Drilling capacity: $\Sigma(t_{N2} + t_{N,II}) \leq 6,50$ mm
	Timber substructures: no performance determined

$t_{N,II}$ [mm]	1,50	2,00	2,50	3,00	4,00	5,00	—	—	—	—	—
$V_{R,k}$ [kN] for $t_{N2} =$	0,40	0,60*	0,60*	0,60*	0,60*	0,60*	0,60*	—	—	—	—
	0,50	1,50*	1,50*	1,50*	1,50*	1,50*	1,50*	—	—	—	—
	0,55	1,50*	1,50*	1,50*	1,50*	1,50*	1,50*	—	—	—	—
	0,60	1,56*	1,56*	1,56*	1,56*	1,56*	1,56*	—	—	—	—
	0,63	1,60*	1,60*	1,60*	1,60*	1,60*	1,60*	—	—	—	—
	0,75	2,70	2,70	2,70	2,70	2,70	2,70	—	—	—	—
	0,88	2,70	2,70	2,70	2,70	2,70	2,70	—	—	—	—
	1,00	2,70	2,70	2,70	2,70	2,70	2,70	—	—	—	—
$N_{R,k}$ [kN] for $t_{N1} =$	0,40	1,57*	1,57*	1,57*	1,57*	1,57*	1,57*	—	—	—	—
	0,50	1,70*	1,70*	1,70*	1,70*	1,70*	1,70*	—	—	—	—
	0,55	1,90	2,00*	2,00*	2,00*	2,00*	2,00*	—	—	—	—
	0,60	1,90	2,13*	2,13*	2,13*	2,13*	2,13*	—	—	—	—
	0,63	1,90	2,20*	2,20*	2,20*	2,20*	2,20*	—	—	—	—
	0,75	1,90	2,60	3,40*	3,40*	3,40*	3,40*	—	—	—	—
	0,88	1,90	2,60	4,10	4,10	4,10	4,10	—	—	—	—
	1,00	1,90	2,60	4,20	4,90	4,90	4,90	—	—	—	—
$N_{R,k,II}$ [kN]	1,90	2,60	4,20	4,90	4,90	4,90	—	—	—	—	
max u [mm] for $D_F =$	40	9,1	5,1	3,3	2,3	1,3	0,9	—	—	—	—
	60	13,6	7,7	4,9	3,4	1,9	1,4	—	—	—	—
	80	18,1	10,2	6,5	4,5	2,6	1,8	—	—	—	—
	100	22,7	12,8	8,2	5,7	3,2	2,3	—	—	—	—
	120	27,2	15,3	9,8	6,8	3,8	2,8	—	—	—	—
	140	31,7	17,9	11,4	7,9	4,5	3,2	—	—	—	—
	≥ 160	36,3	20,4	13,1	9,1	5,1	3,7	—	—	—	—

- $N_{R,k,II}$: Pull-out resistance of component II
- For t_{N2} made of S320GD or S350GD the values $V_{R,k}$ marked with * can be increased by 8,3%.
- For t_{N1} made of S320GD or S350GD the values $N_{R,k}$ marked with * can be increased by 8,3%.

Fastening screws for sandwich panels

Self-drilling screw JT2-D-6-5,5/6,3xL
with hexagon head and sealing washer $\varnothing 16$ mm

Annex 4

Materials:

Fastener: carbon steel
case hardened and corrosion-resistant

Washer: carbon steel, corrosion-resistant
with vulcanised EPDM seal
stainless steel (A2/A4) – EN ISO 3506
with vulcanised EPDM seal

Component I: S280GD to S350GD – EN 10346

Component II: S235 to S355 – EN 10025-1
S280GD to S450GD – EN 10346
HX300LAD to HX460LAD – EN 10346

Drilling capacity: $\Sigma(t_{N2} + t_{N,II}) \leq 6,50$ mm

Timber substructures:
no performance determined

$t_{N,II}$ [mm]	1,50	2,00	2,50	3,00	4,00	5,00	—	—	—	—	—	
$V_{R,k}$ [kN] for $t_{N2} =$	0,40	0,60*	0,60*	0,60*	0,60*	0,60*	0,60*	—	—	—	—	—
	0,50	1,50*	1,50*	1,50*	1,50*	1,50*	1,50*	—	—	—	—	—
	0,55	1,50*	1,50*	1,50*	1,50*	1,50*	1,50*	—	—	—	—	—
	0,60	1,56*	1,56*	1,56*	1,56*	1,56*	1,56*	—	—	—	—	—
	0,63	1,60*	1,60*	1,60*	1,60*	1,60*	1,60*	—	—	—	—	—
	0,75	2,70	2,70	2,70	2,70	2,70	2,70	—	—	—	—	—
	0,88	2,70	2,70	2,70	2,70	2,70	2,70	—	—	—	—	—
	1,00	2,70	2,70	2,70	2,70	2,70	2,70	—	—	—	—	—
$N_{R,k}$ [kN] for $t_{N1} =$	0,40	1,86	1,86*	1,86*	1,86*	1,86*	1,86*	—	—	—	—	—
	0,50	1,90	2,02*	2,02*	2,02*	2,02*	2,02*	—	—	—	—	—
	0,55	1,90	2,45	2,45*	2,45*	2,45*	2,45*	—	—	—	—	—
	0,60	1,90	2,60	2,89*	2,89*	2,89*	2,89*	—	—	—	—	—
	0,63	1,90	2,60	3,15*	3,15*	3,15*	3,15*	—	—	—	—	—
	0,75	1,90	2,60	3,40*	3,40*	3,40*	3,40*	—	—	—	—	—
	0,88	1,90	2,60	4,10	4,10*	4,10*	4,10*	—	—	—	—	—
	1,00	1,90	2,60	4,20	4,90	4,90	4,90	—	—	—	—	—
$N_{R,k,II}$ [kN]	1,90	2,60	4,20	4,90	4,90	4,90	—	—	—	—	—	
$\max u$ [mm] for $D_F =$	40	9,1	5,1	3,3	2,3	1,3	0,9	—	—	—	—	—
	60	13,6	7,7	4,9	3,4	1,9	1,4	—	—	—	—	—
	80	18,1	10,2	6,5	4,5	2,6	1,8	—	—	—	—	—
	100	22,7	12,8	8,2	5,7	3,2	2,3	—	—	—	—	—
	120	27,2	15,3	9,8	6,8	3,8	2,8	—	—	—	—	—
	140	31,7	17,9	11,4	7,9	4,5	3,2	—	—	—	—	—
	≥ 160	36,3	20,4	13,1	9,1	5,1	3,7	—	—	—	—	—

- $N_{R,k,II}$: Pull-out resistance of component II
- For t_{N2} made of S320GD or S350GD the values $V_{R,k}$ marked with * can be increased by 8,3%.
- For t_{N1} made of S320GD or S350GD the values $N_{R,k}$ marked with * can be increased by 8,3%.

Fastening screws for sandwich panels

Self-drilling screw JT2-D-6-5,5/6,3xL
with hexagon head and sealing washer $\varnothing 19$ mm

Annex 5

	<p>Materials:</p> <p>Fastener: carbon steel case hardened and corrosion-resistant</p> <p>Washer: carbon steel, corrosion-resistant with vulcanised EPDM seal stainless steel (A2/A4) – EN ISO 3506 with vulcanised EPDM seal</p> <p>Component I: S280GD to S350GD – EN 10346</p> <p>Component II: S235 to S355 – EN 10025-1 S280GD to S450GD – EN 10346 HX300LAD to HX460LAD – EN 10346</p>
	<p>Drilling capacity: $\Sigma(t_{N2} + t_{N,II}) \leq 6,50$ mm</p>
	<p>Timber substructures: no performance determined</p>

$t_{N,II}$ [mm]	1,50	2,00	2,50	3,00	4,00	5,00	—	—	—	—	—
$V_{R,k}$ [kN] for $t_{N2} =$	0,40	0,60*	0,60*	0,60*	0,60*	0,60*	—	—	—	—	—
	0,50	1,50*	1,50*	1,50*	1,50*	1,50*	—	—	—	—	—
	0,55	1,50*	1,50*	1,50*	1,50*	1,50*	—	—	—	—	—
	0,60	1,56*	1,56*	1,56*	1,56*	1,56*	—	—	—	—	—
	0,63	1,60*	1,60*	1,60*	1,60*	1,60*	—	—	—	—	—
	0,75	2,70	2,70	2,70	2,70	2,70	—	—	—	—	—
	0,88	2,70	2,70	2,70	2,70	2,70	—	—	—	—	—
	1,00	2,70	2,70	2,70	2,70	2,70	—	—	—	—	—
$N_{R,k}$ [kN] for $t_{N1} =$	0,40	1,90	2,16*	2,16*	2,16*	2,16*	—	—	—	—	—
	0,50	1,90	2,28*	2,28*	2,28*	2,28*	—	—	—	—	—
	0,55	1,90	2,60	2,71*	2,71*	2,71*	—	—	—	—	—
	0,60	1,90	2,60	3,14*	3,14*	3,14*	—	—	—	—	—
	0,63	1,90	2,60	3,40*	3,40*	3,40*	—	—	—	—	—
	0,75	1,90	2,60	3,40*	3,40*	3,40*	—	—	—	—	—
	0,88	1,90	2,60	4,10	4,10*	4,10*	—	—	—	—	—
	1,00	1,90	2,60	4,20	4,90	4,90	—	—	—	—	—
$N_{R,k,II}$ [kN]	1,90	2,60	4,20	4,90	4,90	4,90	—	—	—	—	—
$\max u$ [mm] for $D_F =$	40	9,1	5,1	3,3	2,3	1,3	0,9	—	—	—	—
	60	13,6	7,7	4,9	3,4	1,9	1,4	—	—	—	—
	80	18,1	10,2	6,5	4,5	2,6	1,8	—	—	—	—
	100	22,7	12,8	8,2	5,7	3,2	2,3	—	—	—	—
	120	27,2	15,3	9,8	6,8	3,8	2,8	—	—	—	—
	140	31,7	17,9	11,4	7,9	4,5	3,2	—	—	—	—
	≥ 160	36,3	20,4	13,1	9,1	5,1	3,7	—	—	—	—

- $N_{R,k,II}$: Pull-out resistance of component II
- For t_{N2} made of S320GD or S350GD the values $V_{R,k}$ marked with * can be increased by 8,3%.
- For t_{N1} made of S320GD or S350GD the values $N_{R,k}$ marked with * can be increased by 8,3%.

Fastening screws for sandwich panels

Self-drilling screw JT2-D-6-5,5/6,3xL
with hexagonal head and sealing washer $\geq \varnothing 22$ mm

Annex 6

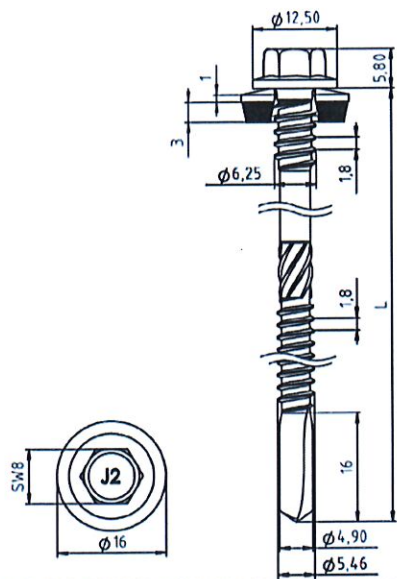

Materials:

Fastener: carbon steel
case hardened and corrosion-resistant

Washer: carbon steel, corrosion-resistant
with vulcanised EPDM seal
stainless steel (A2/A4) – EN ISO 3506
with vulcanised EPDM seal

Component I: S280GD to S350GD – EN 10346

Component II: S235 to S355 – EN 10025-1
S280GD to S350GD – EN 10346

Drilling capacity: $\Sigma(t_{N2} + t_{N,II}) \leq 13,0$ mm

Timber substructures:

no performance determined

$t_{N,II}$ [mm]	3,00	4,00	5,00	6,00	8,00	10,0	12,0	—	—	—	—
$V_{R,k}$ [kN] for $t_{N2} =$	0,40	0,90	0,90	0,90	0,90	0,90	0,90	—	—	—	—
	0,50	0,90	0,90	0,90	0,90	0,90	0,90	—	—	—	—
	0,55	0,90	0,90	0,90	0,90	0,90	0,90	—	—	—	—
	0,60	1,03	1,03	1,03	1,03	1,03	1,03	—	—	—	—
	0,63	1,10	1,10	1,10	1,10	1,10	1,10	—	—	—	—
	0,75	1,60	1,60	1,60	1,60	1,60	1,60	—	—	—	—
	0,88	2,20	2,20	2,20	2,20	2,20	2,20	—	—	—	—
	1,00	2,90	2,90	2,90	2,90	2,90	2,90	—	—	—	—
$N_{R,k}$ [kN] for $t_{N1} =$	0,40	1,54*	1,54*	1,54*	1,54*	1,54*	1,54*	—	—	—	—
	0,50	1,60*	1,60*	1,60*	1,60*	1,60*	1,60*	—	—	—	—
	0,55	1,90*	1,90*	1,90*	1,90*	1,90*	1,90*	—	—	—	—
	0,60	2,09*	2,09*	2,09*	2,09*	2,09*	2,09*	—	—	—	—
	0,63	2,20*	2,20*	2,20*	2,20*	2,20*	2,20*	—	—	—	—
	0,75	2,80	2,80*	2,80*	2,80*	2,80*	2,80*	—	—	—	—
	0,88	3,00	3,50*	3,50*	3,50*	3,50*	3,50*	—	—	—	—
	1,00	3,00	4,20*	4,20*	4,20*	4,20*	4,20*	—	—	—	—
$N_{R,k,II}$ [kN]	3,00	4,70	6,90	6,90	6,90	6,90	6,90	—	—	—	—
max u [mm] for $D_f =$	40	2,3	1,3	0,9	0,9	0,9	0,9	—	—	—	—
	60	3,4	1,9	1,4	1,4	1,4	1,4	—	—	—	—
	80	4,5	2,6	1,8	1,8	1,8	1,8	—	—	—	—
	100	5,7	3,2	2,3	2,3	2,3	2,3	—	—	—	—
	120	6,8	3,8	2,8	2,8	2,8	2,8	—	—	—	—
	140	7,9	4,5	3,2	3,2	3,2	3,2	—	—	—	—
	≥ 160	9,1	5,1	3,7	3,7	3,7	3,7	—	—	—	—

- $N_{R,k,II}$: Pull-out resistance of component II
- For t_{N2} made of S320GD or S350GD the indicated values $V_{R,k}$ can be increased by 8,3%.
- For t_{N1} made of S320GD or S350GD the values $N_{R,k}$ marked with * can be increased by 8,3%.

Fastening screws for sandwich panels

Self-drilling screw JT2-D-12-5,5/6,3xL
with hexagon head and sealing washer $\geq \phi 16$ mm

Annex 7

English translation prepared by DIBt

	Materials: Fastener: carbon steel case hardened and corrosion-resistant Washer: carbon steel, corrosion-resistant with vulcanised EPDM seal stainless steel (A2/A4) – EN ISO 3506 with vulcanised EPDM seal Component I: S280GD to S350GD – EN 10346 Component II: S235 to S355 – EN 10025-1 S280GD to S350GD – EN 10346
	Drilling capacity: $\Sigma(t_{N2} + t_{N,II}) \leq 13,0 \text{ mm}$
Timber substructures: no performance determined	

$t_{N,II}$ [mm]	3,00	4,00	5,00	6,00	8,00	10,0	12,0	—	—	—	—
$V_{R,k}$ [kN] for $t_{N2} =$	0,40	0,90	0,90	0,90	0,90	0,90	0,90	—	—	—	—
	0,50	0,90	0,90	0,90	0,90	0,90	0,90	—	—	—	—
	0,55	0,90	0,90	0,90	0,90	0,90	0,90	—	—	—	—
	0,60	1,03	1,03	1,03	1,03	1,03	1,03	—	—	—	—
	0,63	1,10	1,10	1,10	1,10	1,10	1,10	—	—	—	—
	0,75	1,60	1,60	1,60	1,60	1,60	1,60	—	—	—	—
	0,88	2,20	2,20	2,20	2,20	2,20	2,20	—	—	—	—
	1,00	2,90	2,90	2,90	2,90	2,90	2,90	—	—	—	—
$N_{R,k}$ [kN] for $t_{N1} =$	0,40	1,83*	1,83*	1,83*	1,83*	1,83*	1,83*	—	—	—	—
	0,50	2,02*	2,02*	2,02*	2,02*	2,02*	2,02*	—	—	—	—
	0,55	2,45*	2,45*	2,45*	2,45*	2,45*	2,45*	—	—	—	—
	0,60	2,89	2,89*	2,89*	2,89*	2,89*	2,89*	—	—	—	—
	0,63	3,00	3,15*	3,15*	3,15*	3,15*	3,15*	—	—	—	—
	0,75	3,00	3,15*	3,15*	3,15*	3,15*	3,15*	—	—	—	—
	0,88	3,00	3,50*	3,50*	3,50*	3,50*	3,50*	—	—	—	—
	1,00	3,00	4,20*	4,20*	4,20*	4,20*	4,20*	—	—	—	—
$N_{R,k,II}$ [kN]	3,00	4,70	6,90	6,90	6,90	6,90	6,90	—	—	—	—
$\max u$ [mm] for $D_f =$	40	2,3	1,3	0,9	0,9	0,9	0,9	0,9	—	—	—
	60	3,4	1,9	1,4	1,4	1,4	1,4	1,4	—	—	—
	80	4,5	2,6	1,8	1,8	1,8	1,8	1,8	—	—	—
	100	5,7	3,2	2,3	2,3	2,3	2,3	2,3	—	—	—
	120	6,8	3,8	2,8	2,8	2,8	2,8	2,8	—	—	—
	140	7,9	4,5	3,2	3,2	3,2	3,2	3,2	—	—	—
	≥ 160	9,1	5,1	3,7	3,7	3,7	3,7	3,7	—	—	—

- $N_{R,k,II}$: Pull-out resistance of component II
- For t_{N2} made of S320GD or S350GD the indicated values $V_{R,k}$ can be increased by 8,3%.
- For t_{N1} made of S320GD or S350GD the values $N_{R,k}$ marked with * can be increased by 8,3%.

Fastening screws for sandwich panels

Self-drilling screw JT2-D-12-5,5/6,3xL
with hexagon head and sealing washer $\varnothing 19 \text{ mm}$

Annex 8

English translation prepared by DIBt

Materials:

Fastener: carbon steel
case hardened and corrosion-resistant

Washer: carbon steel, corrosion-resistant
with vulcanised EPDM seal
stainless steel (A2/A4) – EN ISO 3506
with vulcanised EPDM seal

Component I: S280GD to S350GD – EN 10346

Component II: S235 to S355 – EN 10025-1
S280GD to S350GD – EN 10346

Drilling capacity: $\Sigma(t_{N2} + t_{N,II}) \leq 18,0 \text{ mm}$

Timber substructures:
no performance determined

$t_{N,II}$ [mm]	4,00	5,00	6,00	8,00	10,00	12,00	14,00	16,00	—	—	—
$V_{R,k}$ [kN] for $t_{N2} =$	0,40	0,90	0,90	0,90	0,90	0,90	0,90	0,90	—	—	—
	0,50	0,90	0,90	0,90	0,90	0,90	0,90	0,90	—	—	—
	0,55	0,90	0,90	0,90	0,90	0,90	0,90	0,90	—	—	—
	0,60	1,03	1,03	1,03	1,03	1,03	1,03	1,03	—	—	—
	0,63	1,10	1,10	1,10	1,10	1,10	1,10	1,10	—	—	—
	0,75	1,60	1,60	1,60	1,60	1,60	1,60	1,60	—	—	—
	0,88	2,20	2,20	2,20	2,20	2,20	2,20	2,20	—	—	—
	1,00	2,90	2,90	2,90	2,90	2,90	2,90	2,90	—	—	—
$N_{R,k}$ [kN] for $t_{N1} =$	0,40	1,54	1,54	1,54	1,54	1,54	1,54	1,54	—	—	—
	0,50	1,60	1,60	1,60	1,60	1,60	1,60	1,60	—	—	—
	0,55	1,90	1,90	1,90	1,90	1,90	1,90	1,90	—	—	—
	0,60	2,09	2,09	2,09	2,09	2,09	2,09	2,09	—	—	—
	0,63	2,20	2,20	2,20	2,20	2,20	2,20	2,20	—	—	—
	0,75	2,80	2,80	2,80	2,80	2,80	2,80	2,80	—	—	—
	0,88	3,50	3,50	3,50	3,50	3,50	3,50	3,50	—	—	—
	1,00	4,20	4,20	4,20	4,20	4,20	4,20	4,20	—	—	—
$N_{R,k,II}$ [kN]	4,70	6,90	6,90	6,90	6,90	6,90	6,90	6,90	—	—	—
$\max u$ [mm] for $D_f =$	40	1,3	0,9	0,9	0,9	0,9	0,9	0,9	—	—	—
	60	1,9	1,4	1,4	1,4	1,4	1,4	1,4	—	—	—
	80	2,6	1,8	1,8	1,8	1,8	1,8	1,8	—	—	—
	100	3,2	2,3	2,3	2,3	2,3	2,3	2,3	—	—	—
	120	3,8	2,8	2,8	2,8	2,8	2,8	2,8	—	—	—
	140	4,5	3,2	3,2	3,2	3,2	3,2	3,2	—	—	—
	≥ 160	5,1	3,7	3,7	3,7	3,7	3,7	3,7	—	—	—

- $N_{R,k,II}$: Pull-out resistance of component II
- For t_{N2} made of S320GD or S350GD the indicated values $V_{R,k}$ can be increased by 8,3%.
- For t_{N1} made of S320GD or S350GD the values $N_{R,k}$ can be increased by 8,3%.

Fastening screws for sandwich panels

Self-drilling screw JT2-D-18-5,5/6,3xL
with hexagon head and sealing washer $\varnothing 16 \text{ mm}$

Annex 10

English translation prepared by DIBt

	Materials: Fastener: carbon steel case hardened and corrosion-resistant Washer: carbon steel, corrosion-resistant with vulcanised EPDM seal stainless steel (A2/A4) – EN ISO 3506 with vulcanised EPDM seal Component I: S280GD to S350GD – EN 10346 Component II: S235 to S355 – EN 10025-1 S280GD to S350GD – EN 10346
	Drilling capacity: $\Sigma(t_{N2} + t_{N,II}) \leq 18,0 \text{ mm}$
Timber substructures: no performance determined	

$t_{N,II}$ [mm]	4,00	5,00	6,00	8,00	10,00	12,00	14,00	16,00	—	—	—
$V_{R,k}$ [kN] for $t_{N2} =$	0,40	0,90	0,90	0,90	0,90	0,90	0,90	0,90	—	—	—
	0,50	0,90	0,90	0,90	0,90	0,90	0,90	0,90	—	—	—
	0,55	0,90	0,90	0,90	0,90	0,90	0,90	0,90	—	—	—
	0,60	1,03	1,03	1,03	1,03	1,03	1,03	1,03	—	—	—
	0,63	1,10	1,10	1,10	1,10	1,10	1,10	1,10	—	—	—
	0,75	1,60	1,60	1,60	1,60	1,60	1,60	1,60	—	—	—
	0,88	2,20	2,20	2,20	2,20	2,20	2,20	2,20	—	—	—
	1,00	2,90	2,90	2,90	2,90	2,90	2,90	2,90	—	—	—
$N_{R,k}$ [kN] for $t_{N1} =$	0,40	1,83	1,83	1,83	1,83	1,83	1,83	1,83	—	—	—
	0,50	2,02	2,02	2,02	2,02	2,02	2,02	2,02	—	—	—
	0,55	2,45	2,45	2,45	2,45	2,45	2,45	2,45	—	—	—
	0,60	2,89	2,89	2,89	2,89	2,89	2,89	2,89	—	—	—
	0,63	3,15	3,15	3,15	3,15	3,15	3,15	3,15	—	—	—
	0,75	3,15	3,15	3,15	3,15	3,15	3,15	3,15	—	—	—
	0,88	3,50	3,50	3,50	3,50	3,50	3,50	3,50	—	—	—
	1,00	4,20	4,20	4,20	4,20	4,20	4,20	4,20	—	—	—
$N_{R,k,II}$ [kN]	4,70	6,90	6,90	6,90	6,90	6,90	6,90	6,90	—	—	—
$\max u$ [mm] for $D_F =$	40	1,3	0,9	0,9	0,9	0,9	0,9	0,9	—	—	—
	60	1,9	1,4	1,4	1,4	1,4	1,4	1,4	—	—	—
	80	2,6	1,8	1,8	1,8	1,8	1,8	1,8	—	—	—
	100	3,2	2,3	2,3	2,3	2,3	2,3	2,3	—	—	—
	120	3,8	2,8	2,8	2,8	2,8	2,8	2,8	—	—	—
	140	4,5	3,2	3,2	3,2	3,2	3,2	3,2	—	—	—
	≥ 160	5,1	3,7	3,7	3,7	3,7	3,7	3,7	—	—	—

- $N_{R,k,II}$: Pull-out resistance of component II
- For t_{N2} made of S320GD or S350GD the indicated values $V_{R,k}$ can be increased by 8,3%.
- For t_{N1} made of S320GD or S350GD the indicated values $N_{R,k}$ can be increased by 8,3%.

Fastening screws for sandwich panels

Self-drilling screw JT2-D-18-5,5/6,3xL
with hexagon head and sealing washer $\varnothing 19 \text{ mm}$

Annex 11

English translation prepared by DIBt

Material:

Fastener: carbon steel
case hardened and corrosion-resistant

Washer: carbon steel, corrosion-resistant
with vulcanised EPDM seal
stainless steel (A2/A4) – EN ISO 3506
with vulcanised EPDM seal

Component I: S280GD to S350GD – EN 10346

Component II: S235 to S355 – EN 10025-1
S280GD to S350GD – EN 10346

Drilling capacity: $\Sigma(t_{N2} + t_{N,II}) \leq 18,0 \text{ mm}$

Timber substructures:
no performance determined

$t_{N,II}$ [mm]	4,00	5,00	6,00	8,00	10,00	12,00	14,00	16,00	—	—	—
$V_{R,k}$ [kN] for $t_{N2} =$	0,40	0,90	0,90	0,90	0,90	0,90	0,90	0,90	—	—	—
	0,50	0,90	0,90	0,90	0,90	0,90	0,90	0,90	—	—	—
	0,55	0,90	0,90	0,90	0,90	0,90	0,90	0,90	—	—	—
	0,60	1,03	1,03	1,03	1,03	1,03	1,03	1,03	—	—	—
	0,63	1,10	1,10	1,10	1,10	1,10	1,10	1,10	—	—	—
	0,75	1,60	1,60	1,60	1,60	1,60	1,60	1,60	—	—	—
	0,88	2,20	2,20	2,20	2,20	2,20	2,20	2,20	—	—	—
	1,00	2,90	2,90	2,90	2,90	2,90	2,90	2,90	—	—	—
$N_{R,k}$ [kN] for $t_{N1} =$	0,40	2,12	2,12	2,12	2,12	2,12	2,12	2,12	—	—	—
	0,50	2,28	2,28	2,28	2,28	2,28	2,28	2,28	—	—	—
	0,55	2,71	2,71	2,71	2,71	2,71	2,71	2,71	—	—	—
	0,60	3,14	3,14	3,14	3,14	3,14	3,14	3,14	—	—	—
	0,63	3,40	3,40	3,40	3,40	3,40	3,40	3,40	—	—	—
	0,75	3,40	3,40	3,40	3,40	3,40	3,40	3,40	—	—	—
	0,88	3,50	3,50	3,50	3,50	3,50	3,50	3,50	—	—	—
	1,00	4,20	4,20	4,20	4,20	4,20	4,20	4,20	—	—	—
$N_{R,k,II}$ [kN]	4,70	6,90	6,90	6,90	6,90	6,90	6,90	6,90	—	—	—
$\max u$ [mm] for $D_F =$	40	1,3	0,9	0,9	0,9	0,9	0,9	0,9	—	—	—
	60	1,9	1,4	1,4	1,4	1,4	1,4	1,4	—	—	—
	80	2,6	1,8	1,8	1,8	1,8	1,8	1,8	—	—	—
	100	3,2	2,3	2,3	2,3	2,3	2,3	2,3	—	—	—
	120	3,8	2,8	2,8	2,8	2,8	2,8	2,8	—	—	—
	140	4,5	3,2	3,2	3,2	3,2	3,2	3,2	—	—	—
	≥ 160	5,1	3,7	3,7	3,7	3,7	3,7	3,7	—	—	—

- $N_{R,k,II}$: Pull-out resistance of component II
- For t_{N2} made of S320GD or S350GD the indicated values $V_{R,k}$ can be increased by 8,3%.
- For t_{N1} made of S320GD or S350GD the indicated values $N_{R,k}$ can be increased by 8,3%.

Fastening screws for sandwich panels

Self-drilling screw JT2-D-18-5,5/6,3xL
with hexagon head and sealing washer $\geq \varnothing 22 \text{ mm}$

Annex 12

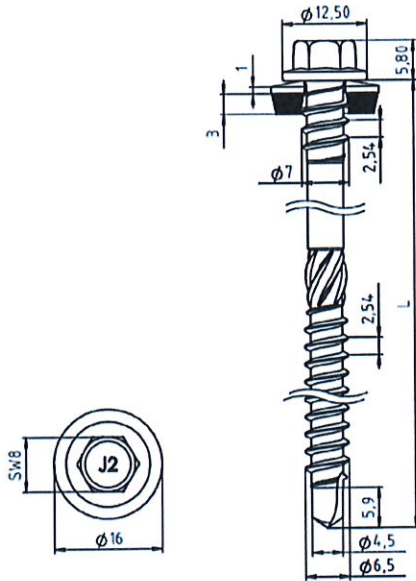

Materials

Fastener: carbon steel
case hardened and corrosion-resistant

Washer: carbon steel, corrosion-resistant
with vulcanised EPDM seal
stainless steel (A2/A4) – EN ISO 3506
with vulcanised EPDM seal

Component I: S280GD to S350GD – EN 10346

Component II: timber – EN 14081

Drilling capacity: $t_{N2} \leq 2,00$ mm

Timber substructures:

performance determined with

$M_{y,Rk} = 9,742$ Nm

$f_{ax,k} = 11,810$ N/mm² for $l_{ef} \geq 44$ mm

l_g [mm]	50	53	56	59	62	65	68	71	74	77	80		
$V_{R,k}$ [kN] for $t_{N2} =$	0,40	1,03	1,03	1,03	1,03	1,03	1,03	1,03	1,03	1,03	1,03	1,03	$V_{R,k,l}$ [kN]
	0,50	1,10	1,10	1,10	1,10	1,10	1,10	1,10	1,10	1,10	1,10	1,10	1,10
	0,55	1,20	1,20	1,20	1,20	1,20	1,20	1,20	1,20	1,20	1,20	1,20	1,20
	0,60	1,26	1,26	1,26	1,26	1,26	1,26	1,26	1,26	1,26	1,26	1,26	1,26
	0,63	1,30	1,30	1,30	1,30	1,30	1,30	1,30	1,30	1,30	1,30	1,30	1,30
	0,75	1,30	1,30	1,30	1,30	1,30	1,30	1,30	1,30	1,30	1,30	1,30	1,30
	0,88	1,30	1,30	1,30	1,30	1,30	1,30	1,30	1,30	1,30	1,30	1,30	1,30
	1,00	1,30	1,30	1,30	1,30	1,30	1,30	1,30	1,30	1,30	1,30	1,30	1,30
$N_{R,k}$ [kN] for $t_{N1} =$	0,40	1,57*	1,57*	1,57*	1,57*	1,57*	1,57*	1,57*	1,57*	1,57*	1,57*	1,57*	$N_{R,k,l}$ [kN]
	0,50	1,70*	1,70*	1,70*	1,70*	1,70*	1,70*	1,70*	1,70*	1,70*	1,70*	1,70*	1,70*
	0,55	2,00*	2,00*	2,00*	2,00*	2,00*	2,00*	2,00*	2,00*	2,00*	2,00*	2,00*	2,00*
	0,60	2,13*	2,13*	2,13*	2,13*	2,13*	2,13*	2,13*	2,13*	2,13*	2,13*	2,13*	2,13*
	0,63	2,20*	2,20*	2,20*	2,20*	2,20*	2,20*	2,20*	2,20*	2,20*	2,20*	2,20*	2,20*
	0,75	3,04	3,25	3,40	3,40*	3,40*	3,40*	3,40*	3,40*	3,40*	3,40*	3,40*	3,40*
	0,88	3,04	3,25	3,45	3,66	3,87	4,08	4,10	4,10	4,10*	4,10*	4,10*	4,10*
	1,00	3,04	3,25	3,45	3,66	3,87	4,08	4,28	4,49	4,70	4,90	4,90	4,90*
$\max u$ [mm] for $D_F =$	30	0,9	0,9	0,9	0,9	0,9	0,9	0,9	0,9	0,9	0,9	0,9	$\max u$ [mm] for $D_F =$
	40	1,4	1,4	1,4	1,4	1,4	1,4	1,4	1,4	1,4	1,4	1,4	1,4
	60	1,8	1,8	1,8	1,8	1,8	1,8	1,8	1,8	1,8	1,8	1,8	1,8
	80	2,3	2,3	2,3	2,3	2,3	2,3	2,3	2,3	2,3	2,3	2,3	2,3
	100	2,8	2,8	2,8	2,8	2,8	2,8	2,8	2,8	2,8	2,8	2,8	2,8
	120	3,2	3,2	3,2	3,2	3,2	3,2	3,2	3,2	3,2	3,2	3,2	3,2
	≥ 140	3,7	3,7	3,7	3,7	3,7	3,7	3,7	3,7	3,7	3,7	3,7	3,7

- The values indicated above, depending on the screw depth l_g shall apply to $k_{mod} = 0,90$ and the timber strength class C24 ($\rho_k = 350$ kg/m³). For other values of k_{mod} and strength classes see Annex 3.
- For t_{N2} made of S320GD or S350GD the indicated values $V_{R,k}$ can be increased by 8,3%.
- For t_{N1} made of S320GD or S350GD the values $N_{R,k}$ marked with * can be increased by 8,3%.

Fastening screws for sandwich panels

Self-drilling screw JT-D-2-6,5/7,0xL
with hexagon head and sealing washer $\geq \varnothing 16$ mm

Annex 13

	Materials Fastener: carbon steel case hardened and corrosion-resistant Washer: carbon steel, corrosion-resistant with vulcanised EPDM seal stainless steel (A2/A4) – EN ISO 3506 with vulcanised EPDM seal Component I: S280GD to S350GD – EN 10346 Component II: timber – EN 14081
	Drilling capacity: $t_{N2} \leq 2,00$ mm
	Timber substructures: performance determined with $M_{y,Rk} = 9,742$ Nm $f_{ax,k} = 11,810$ N/mm ² for $l_{ef} \geq 44$ mm

l_g [mm]	50	53	56	59	62	65	68	71	74	77	80		
$V_{R,k}$ [kN] for $t_{N2} =$	0,40	1,03	1,03	1,03	1,03	1,03	1,03	1,03	1,03	1,03	1,03	1,03	$V_{R,k,i}$ [kN]
	0,50	1,10	1,10	1,10	1,10	1,10	1,10	1,10	1,10	1,10	1,10	1,10	
	0,55	1,20	1,20	1,20	1,20	1,20	1,20	1,20	1,20	1,20	1,20	1,20	
	0,60	1,26	1,26	1,26	1,26	1,26	1,26	1,26	1,26	1,26	1,26	1,26	
	0,63	1,30	1,30	1,30	1,30	1,30	1,30	1,30	1,30	1,30	1,30	1,30	
	0,75	1,30	1,30	1,30	1,30	1,30	1,30	1,30	1,30	1,30	1,30	1,30	
	0,88	1,30	1,30	1,30	1,30	1,30	1,30	1,30	1,30	1,30	1,30	1,30	
	1,00	1,30	1,30	1,30	1,30	1,30	1,30	1,30	1,30	1,30	1,30	1,30	
$N_{R,k}$ [kN] for $t_{N1} =$	0,40	1,86*	1,86*	1,86*	1,86*	1,86*	1,86*	1,86*	1,86*	1,86*	1,86*	1,86*	$N_{R,k,i}$ [kN]
	0,50	2,02*	2,02*	2,02*	2,02*	2,02*	2,02*	2,02*	2,02*	2,02*	2,02*	2,02*	
	0,55	2,45*	2,45*	2,45*	2,45*	2,45*	2,45*	2,45*	2,45*	2,45*	2,45*	2,45*	
	0,60	2,89	2,89*	2,89*	2,89*	2,89*	2,89*	2,89*	2,89*	2,89*	2,89*	2,89*	
	0,63	3,04	3,15	3,15*	3,15*	3,15*	3,15*	3,15*	3,15*	3,15*	3,15*	3,15*	
	0,75	3,04	3,25	3,40	3,40	3,40*	3,40*	3,40*	3,40*	3,40*	3,40*	3,40*	
	0,88	3,04	3,25	3,45	3,66	3,87	4,08	4,10	4,10*	4,10*	4,10*	4,10*	
	1,00	3,04	3,25	3,45	3,66	3,87	4,08	4,28	4,49	4,70	4,90	4,90*	
$\max u$ [mm] for $D_F =$	30	0,9	0,9	0,9	0,9	0,9	0,9	0,9	0,9	0,9	0,9	0,9	$\max u$ [mm] for $D_F =$
	40	1,4	1,4	1,4	1,4	1,4	1,4	1,4	1,4	1,4	1,4	1,4	
	60	1,8	1,8	1,8	1,8	1,8	1,8	1,8	1,8	1,8	1,8	1,8	
	80	2,3	2,3	2,3	2,3	2,3	2,3	2,3	2,3	2,3	2,3	2,3	
	100	2,8	2,8	2,8	2,8	2,8	2,8	2,8	2,8	2,8	2,8	2,8	
	120	3,2	3,2	3,2	3,2	3,2	3,2	3,2	3,2	3,2	3,2	3,2	
	≥ 140	3,7	3,7	3,7	3,7	3,7	3,7	3,7	3,7	3,7	3,7	3,7	

- The values indicated above, depending on the screw depth l_g shall apply to $k_{mod} = 0,90$ and the timber strength class C24 ($\rho_k = 350$ kg/m³). For other values of k_{mod} and strength classes see Annex 3.
- For t_{N2} made of S320GD or S350GD the indicated values $V_{R,k}$ can be increased by 8,3%.
- For t_{N1} made of S320GD or S350GD the values $N_{R,k}$ marked with * can be increased by 8,3%.

Fastening screws for sandwich panels

Self-drilling screw JT2-D-2-6,5/7,0xL
with hexagon head and sealing washer $\geq \varnothing 19$ mm

Annex 14

	Materials Fastener: carbon steel case hardened and corrosion-resistant Washer: carbon steel, corrosion-resistant with vulcanised EPDM seal stainless steel (A2/A4) – EN ISO 3506 with vulcanised EPDM seal Component I: S280GD to S350GD – EN 10346 Component II: timber – EN 14081
	Drilling capacity: $t_{N2} \leq 2,00 \text{ mm}$
	Timber substructures: performance determined with $M_{y,Rk} = 9,742 \text{ Nm}$ $f_{ax,k} = 11,810 \text{ N/mm}^2$ for $l_{ef} \geq 44 \text{ mm}$

l_g [mm]	50	53	56	59	62	65	68	71	74	77	80		
$V_{R,k}$ [kN] for $t_{N2} =$	0,40	1,03	1,03	1,03	1,03	1,03	1,03	1,03	1,03	1,03	1,03	1,03	$V_{R,k,i}$ [kN]
	0,50	1,10	1,10	1,10	1,10	1,10	1,10	1,10	1,10	1,10	1,10	1,10	1,10
	0,55	1,20	1,20	1,20	1,20	1,20	1,20	1,20	1,20	1,20	1,20	1,20	1,20
	0,60	1,26	1,26	1,26	1,26	1,26	1,26	1,26	1,26	1,26	1,26	1,26	1,26
	0,63	1,30	1,30	1,30	1,30	1,30	1,30	1,30	1,30	1,30	1,30	1,30	1,30
	0,75	1,30	1,30	1,30	1,30	1,30	1,30	1,30	1,30	1,30	1,30	1,30	1,30
	0,88	1,30	1,30	1,30	1,30	1,30	1,30	1,30	1,30	1,30	1,30	1,30	1,30
	1,00	1,30	1,30	1,30	1,30	1,30	1,30	1,30	1,30	1,30	1,30	1,30	1,30
$N_{R,k}$ [kN] for $t_{N1} =$	0,40	2,16*	2,16*	2,16*	2,16*	2,16*	2,16*	2,16*	2,16*	2,16*	2,16*	2,16*	$N_{R,k,i}$ [kN]
	0,50	2,28*	2,28*	2,28*	2,28*	2,28*	2,28*	2,28*	2,28*	2,28*	2,28*	2,28*	2,28*
	0,55	2,71*	2,71*	2,71*	2,71*	2,71*	2,71*	2,71*	2,71*	2,71*	2,71*	2,71*	2,71*
	0,60	3,04	3,14	3,14*	3,14*	3,14*	3,14*	3,14*	3,14*	3,14*	3,14*	3,14*	3,14*
	0,63	3,04	3,25	3,40	3,40	3,40*	3,40*	3,40*	3,40*	3,40*	3,40*	3,40*	3,40*
	0,75	3,04	3,25	3,40	3,40	3,40*	3,40*	3,40*	3,40*	3,40*	3,40*	3,40*	3,40*
	0,88	3,04	3,25	3,45	3,66	3,87	4,08	4,10	4,10*	4,10*	4,10*	4,10*	4,10*
	1,00	3,04	3,25	3,45	3,66	3,87	4,08	4,28	4,49	4,70	4,90	4,90	4,90
$\max u$ [mm] for $D_F =$	30	0,9	0,9	0,9	0,9	0,9	0,9	0,9	0,9	0,9	0,9	0,9	$\max u$ [mm] for $D_F =$
	40	1,4	1,4	1,4	1,4	1,4	1,4	1,4	1,4	1,4	1,4	1,4	1,4
	60	1,8	1,8	1,8	1,8	1,8	1,8	1,8	1,8	1,8	1,8	1,8	1,8
	80	2,3	2,3	2,3	2,3	2,3	2,3	2,3	2,3	2,3	2,3	2,3	2,3
	100	2,8	2,8	2,8	2,8	2,8	2,8	2,8	2,8	2,8	2,8	2,8	2,8
	120	3,2	3,2	3,2	3,2	3,2	3,2	3,2	3,2	3,2	3,2	3,2	3,2
	≥ 140	3,7	3,7	3,7	3,7	3,7	3,7	3,7	3,7	3,7	3,7	3,7	3,7

- The values indicated above, depending on the screw depth l_g shall apply to $k_{mod} = 0,90$ and the timber strength class C24 ($\rho_k = 350 \text{ kg/m}^3$). For other values of k_{mod} and strength classes see Annex 3.
- For t_{N2} made of S320GD or S350GD the indicated values $V_{R,k}$ can be increased by 8,3%.
- For t_{N1} made of S320GD or S350GD the values $N_{R,k}$ marked with * can be increased by 8,3%.

Fastening screws for sandwich panels

Self-drilling screw JT2-D-2-6,5/7,0xL
with hexagon head and sealing washer $\geq \text{Ø}22 \text{ mm}$

Annex 15