

Series RV1

R412007692

Safety valves

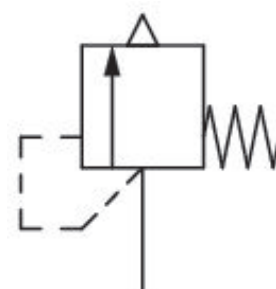

Technical data

Industry
Industrial

Compressed air connection 1
G 1/2

Compressed air connection type 1
External thread

Mounting
thread-in

Compressed air connection type 2
Uncollected

Type
Poppet valve

Opening pressure of valve
5 bar

Nominal flow Qn 1 to 2
5604 l/min

Working pressure min.
0 bar

Working pressure max
20 bar

Min. ambient temperature
-20 °C

Max. ambient temperature
100 °C

Medium
Compressed air

Certificates
CE declaration of conformity

Material

Housing material
Brass

Part No.
R412007692

Seal material
Fluorocaoutchouc

Technical information

The specified performance values are achieved at a 10% (PE <[[1] bar], [[0,1] bar]) pressure increase, measured with compressed air at [[20]°C].

The min. control pressure must be adhered to, since otherwise faulty switching and valve failure may result!

The pressure dew point must be at least 15 °C under ambient and medium temperature and may not exceed 3 °C .

The oil content of compressed air must remain constant during the life cycle.

Use only the approved oils from AVENTICS. Further information can be found in the “Technical information” document (available in <https://www.emerson.com/en-us/support>).

Dimensions

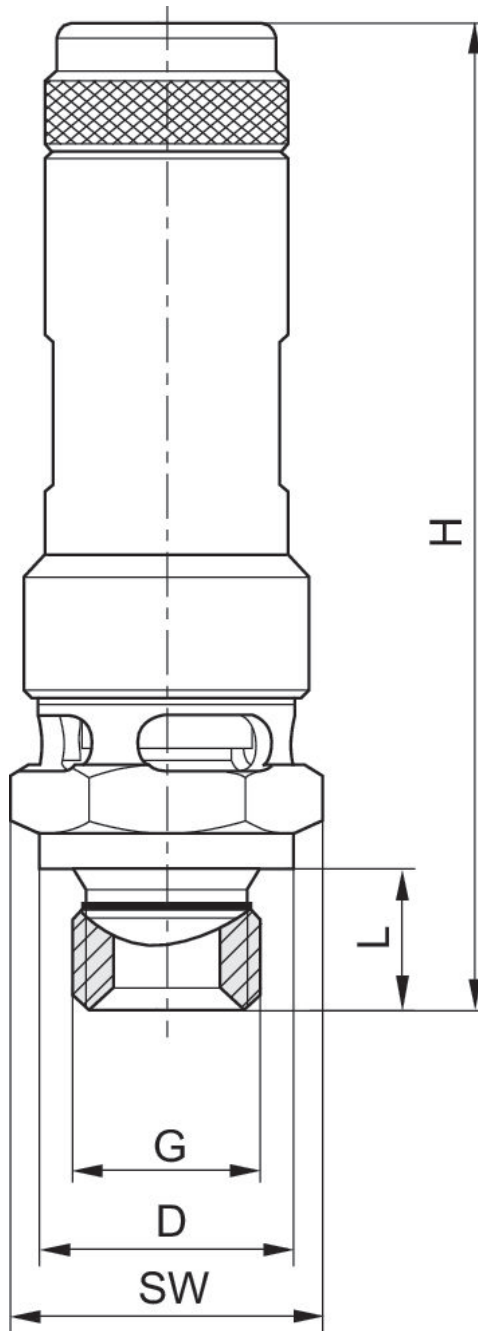

G = connection 1

Part No. G 1/4	Port G	Ø D	H	L	SW	T [Nm]	NW
R412007521	G 1/4	18	69	10	19	30	8
R412007522	G 1/4	18	69	10	19	30	8
R412007523	G 1/4	18	69	10	19	30	8
R412007524	G 1/4	18	69	10	19	30	8
R412007525	G 1/4	18	69	10	19	30	8
R412007526	G 1/4	18	69	10	19	30	8

Part No. G 1/4	Port G	Ø D	H	L	SW	T [Nm]	NW
R412007527	G 1/4	18	69	10	19	30	8
R412007528	G 1/4	18	69	10	19	30	8
R412007529	G 1/4	18	69	10	19	30	8
R412007530	G 1/4	18	69	10	19	30	8
R412007531	G 1/4	18	69	10	19	30	8
R412007532	G 1/4	18	69	10	19	30	8
R412007533	G 3/8	22	75	10	24	40	10
R412007534	G 3/8	22	75	10	24	40	10
R412007535	G 3/8	22	75	10	24	40	10
R412007721	G 3/8	22	75	10	24	40	10
R412007536	G 3/8	22	75	10	24	40	10
R412007537	G 3/8	22	75	10	24	40	10
R412007538	G 3/8	22	75	10	24	40	10
R412007539	G 3/8	22	88	10	24	40	10
R412007540	G 3/8	22	88	10	24	40	10
R412007541	G 3/8	22	88	10	24	40	10
R412007542	G 1/2	26	78	12	27	50	15
R412007720	G 1/2	26	78	12	27	50	15
R412007690	G 1/2	26	78	12	27	50	15
R412007691	G 1/2	26	78	12	27	50	15
R412007692	G 1/2	26	78	12	27	50	15
R412007699	G 1/2	26	78	12	27	50	15
R412007696	G 1/2	26	78	12	27	50	15
R412007702	G 1/2	26	78	12	27	50	15
R412007698	G 1/2	26	78	12	27	50	15
R412007697	G 1/2	26	77.5	12	27	50	15
R412007693	G 1/2	26	91	12	27	50	15
R412007694	G 1/2	26	91	12	27	50	15
R412007700	G 1/2	26	91	12	27	50	15
R412007701	G 1/2	26	91	12	27	50	15
R412007695	G 1/2	26	91	12	27	50	15
R412007703	G 1/2	26	91	12	27	50	15
R412007543	G 1/2	26	91	12	27	50	15
R412007544	G 3/4	32	106	12	30	60	20
R412007684	G 3/4	32	106	12	30	60	20
R412007545	G 3/4	32	106	12	30	60	20
R412007546	G 3/4	32	106	12	30	60	20
R412007547	G 3/4	32	106	12	30	60	20
R412007548	G 3/4	32	106	12	30	60	20
R412007549	G 3/4	32	116	12	30	60	20
R412007550	G 3/4	32	116	12	30	60	20
R412007551	G 3/4	32	116	12	30	60	20
R412007552	G 3/4	32	116	12	30	60	20

T = maximum torque
NW = nominal width