

Series QR2-S-RSI standard

1823391761

General series information

Series QR2-S, standard

- AVENTICS Series QR2, push-in connectors with easy, secure mounting are available in many versions: In metal for tubing diameters from 3 to 16 mm. QR2 Series offers a cylindric thread that allows repeated connection and release without problems (Quick Release) and captive O-ring guarantees an optimal sealing. Our QR program offers the right solution for every application and industry.

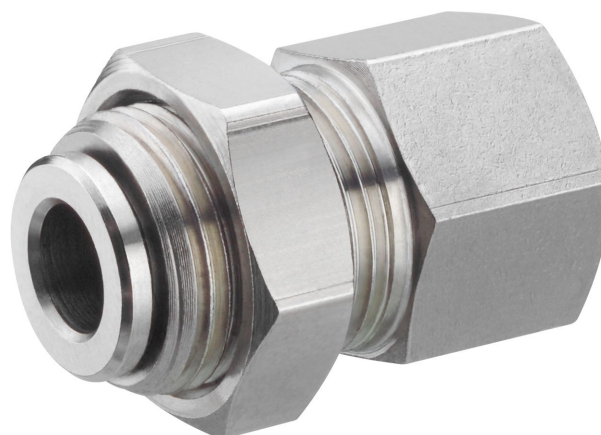

Technical data

Industry

Industrial

Fitting type

Bulkhead connector

Compressed air connection type

Internal thread

Port G

G 1/4

Compressed air connection type 2

push-in fitting

Port D

Ø 8

Type

QR2-S-RSI

Working pressure min.

-0.95 bar

Working pressure max

16 bar

Min. ambient temperature

-20 °C

Max. ambient temperature

80 °C

Delivery unit

10 piece

Material

Housing material

Brass

Surface housing

nickel-plated

Seal material

Acrylonitrile butadiene rubber

Material tooth lock washer

Stainless Steel

Material release ring

Brass

Surface release ring

nickel-plated

Material thread

Brass

Surface thread

nickel-plated

Part No.
1823391761

Technical information

The series QR1 (plastic) and QR2 (metal) can not be combined

Dimensions

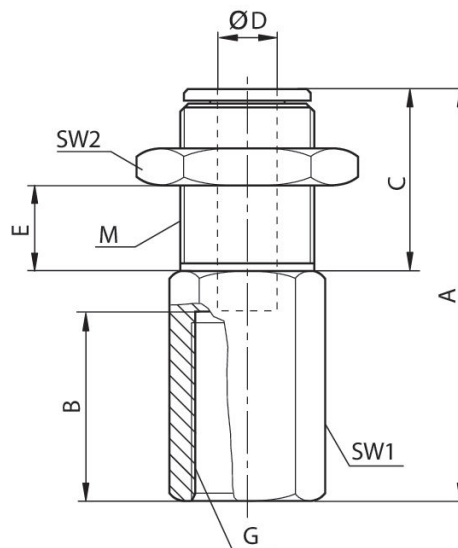

Part No.	Port D	Port G	M	A	B	C	E ±2 max.	SW1	SW2
1823391757	Ø 4	G 1/8	M10x1	25	8.5	15	9.5	15	13
1823391758	Ø 6	G 1/8	M14x1	26	8.5	15	9.5	17	17
1823391759	Ø 6	G 1/4	M14x1	30.5	13	15	9.5	17	17
1823391760	Ø 8	G 1/8	M16x1	28	8.5	15	9.5	17	19
1823391761	Ø 8	G 1/4	M16x1	33	13	15	9.5	17	19