

Dıştan kapaklı kanallar

Cable trunking with
external cover

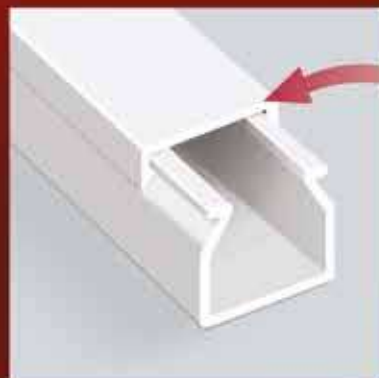
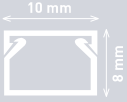

Dıştan Kapaklı
External Cover

**10x8****Aksesuarsız**
Without Accessories

		EKO Serisi Series	MEKS Serisi Series
Ürün Kodu	Product Code	001 014 010008 20 00	001 002 010008 20 00
Ambalaj Şekli	Packing Type	Kutu - Box	Kutu - Box
Adet / m	Quantity / m	330 m	330 m
Ağırlık	Weight	17,500	17,500
m ³ /	Volume	0,04000	0,04000

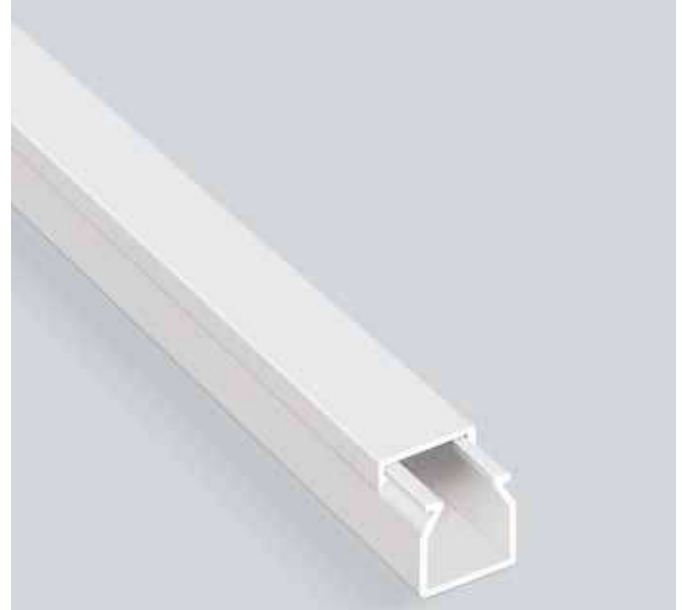
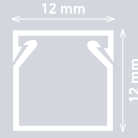
**12x12**

		EKO Serisi Series	MEKS Serisi Series	CANALEX Serisi Series
Ürün Kodu	Product Code	001 014 012012 20 00	001 002 012012 20 00	001 156 012012 20 00
Ambalaj Şekli	Packing Type	Kutu - Box	Kutu - Box	Kutu - Box
Adet / m	Quantity / m	250 m	250 m	250 m
Ağırlık	Weight	17,050 kg	17,050 kg	14,800 kg
m ³ /	Volume	0,05090	0,05090	0,05090

**AKSESUARLAR - ACCESSORIES**

	Kod Code	Ürün Product	Adet Quantity	Ağırlık Weight	m ³ Volume
	001 039 012012 00 00	İç Köşe Internal Corner	60	0,175 kg	0,00139
	001 040 012012 00 00	Dış Köşe External Corner	60	0,215 kg	0,00139
	001 041 012012 00 00	T Köşe T Corner	60	0,195 kg	0,00139
	001 042 012012 00 00	90° L Köşe 90° L Corner	60	0,225 kg	0,00139
	001 043 012012 00 00	Ek Parça Connector	100	0,165 kg	0,00139
	001 044 012012 00 00	Uç Tapa Blind Cap	100	0,145 kg	0,00139

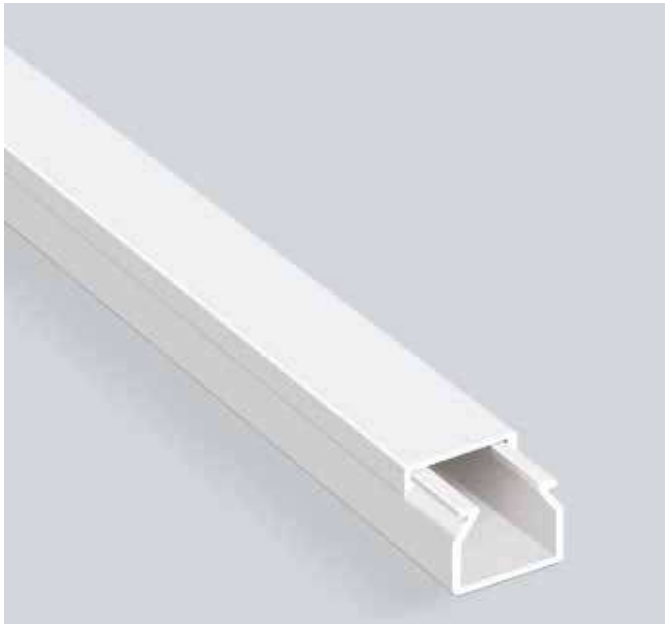

15x10

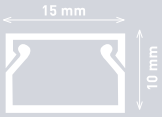

		EKO Seri Si Series	MEKS Seri Si Series	CANALEX Seri Si Series
Ürün Kodu	Product Code	001 014 015010 20 00	001 002 015010 20 00	001 156 015010 20 00
Ambalaj Şekli	Packing Type	Kutu - Box	Kutu - Box	Kutu - Box
Adet / m	Quantity / m	250 m	250 m	250 m
Ağırlık	Weight	19,800 kg	19,800 kg	14,800 kg
m ³ /	Volume	0,05090	0,05090	0,05090

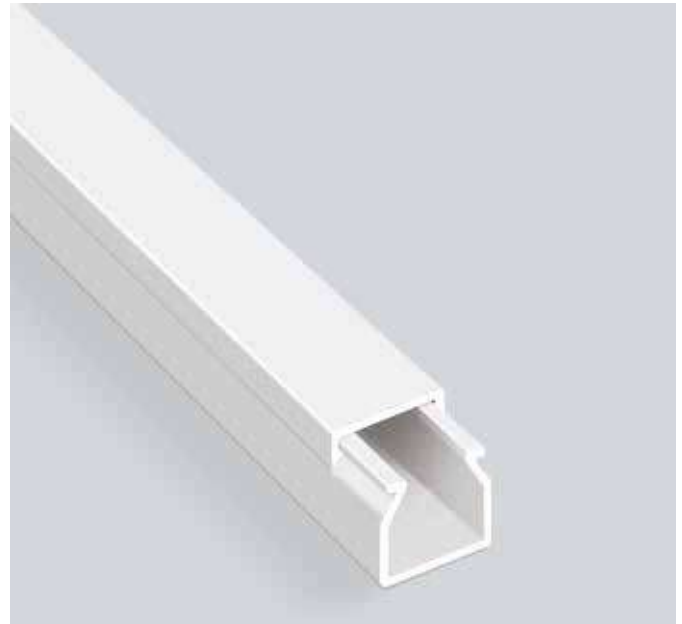

15x15

Aksesuarsız
Without Accessories

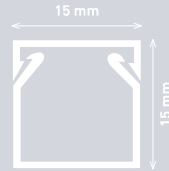

		EKO Seri Si Series	MEKS Seri Si Series
Ürün Kodu	Product Code	001 014 015015 20 00	001 002 015015 20 00
Ambalaj Şekli	Packing Type	Kutu - Box	Kutu - Box
Adet / m	Quantity / m	250 m	250 m
Ağırlık	Weight	23 kg	23 kg
m ³ /	Volume	0,07636	0,07636

AKSESUARLAR - ACCESSORIES

	Kod Code	Ürün Product	Adet Quantity	Ağırlık Weight	m ³ Volume
	001 039 015010 00 00	İç Köşe Internal Corner	60	0,195 kg	0,00139
	001 040 015010 00 00	Dış Köşe External Corner	60	0,220 kg	0,00139
	001 041 015010 00 00	T Köşe T Corner	60	0,240 kg	0,00139
	001 042 015010 00 00	90° L Köşe 90° L Corner	60	0,190 kg	0,00139
	001 043 015010 00 00	Ek Parça Connector	100	0,250 kg	0,00139
	001 044 015010 00 00	Uç Tapa Blind Cap	100	0,150 kg	0,00139







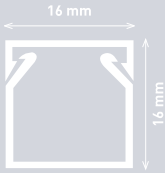

16x16



		EKO Seri Series	MEKS Seri Series	CANALEX Seri Series
Ürün Kodu	Product Code	001 014 016016 20 00	001 002 016016 20 00	001 156 016016 20 00
Ambalaj Şekli	Packing Type	Kutu - Box	Kutu - Box	Kutu - Box
Adet / m	Quantity / m	250 m	250 m	250 m
Ağırlık	Weight	26,900 kg	27,390 kg	20,650 kg
m ³ /	Volume	0,07636	0,07636	0,07636

AKSESUARLAR - ACCESSORIES

	Kod Code	Ürün Product	Adet Quantity	Ağırlık Weight	m ³ Volume
	001 039 016016 00 00	İç Köşe Internal Corner	60	0,240 kg	0,00293
	001 040 016016 00 00	Dış Köşe External Corner	60	0,265 kg	0,00293
	001 041 016016 00 00	T Köşe T Corner	60	0,400 kg	0,00293
	001 042 016016 00 00	90° L Köşe 90° L Corner	60	0,330 kg	0,00293
	001 043 016016 00 00	Ek Parça Connector	100	0,250 kg	0,00139
	001 044 016016 00 00	Uç Tapa Blind Cap	100	0,190 kg	0,00139



20x10

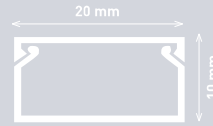

		EKO Seri Series	MEKS Seri Series	CANALEX Seri Series
Ürün Kodu	Product Code	001 014 020010 20 00	001 002 020010 20 00	001 156 020010 20 00
Ambalaj Şekli	Packing Type	Kutu - Box	Kutu - Box	Kutu - Box
Adet / m	Quantity / m	200 m	200 m	200 m
Ağırlık	Weight	17,050 kg	17,050 kg	15,060 kg
m ³ /	Volume	0,05090	0,05090	0,05090

AKSESUARLAR - ACCESSORIES

	Kod Code	Ürün Product	Adet Quantity	Ağırlık Weight	m ³ Volume
	001 039 020010 00 00	İç Köşe Internal Corner	60	0,200 kg	0,00139
	001 040 020010 00 00	Dış Köşe External Corner	60	0,245 kg	0,00139
	001 041 020010 00 00	T Köşe T Corner	30	0,170 kg	0,00139
	001 042 020010 00 00	90° L Köşe 90° L Corner	50	0,240 kg	0,00293
	001 043 020010 00 00	Ek Parça Connector	100	0,210 kg	0,00139
	001 044 020010 00 00	Uç Tapa Blind Cap	100	0,200 kg	0,00139



20x15



		EKO <small>Serisi</small>	MEKS <small>Serisi</small>
Ürün Kodu	Product Code	001 014 020015 20 00	001 002 020015 20 00
Ambalaj Şekli	Packing Type	Kutu - Box	Kutu - Box
Adet / m	Quantity / m	144 m	144 m
Ağırlık	Weight	15,120 kg	15,120 kg
m ³ /	Volume	0,07636	0,07636



20x20 | **Aksesuarsız**
Without Accessories



		EKO <small>Serisi</small>	MEKS <small>Serisi</small>
Ürün Kodu	Product Code	001 014 020020 20 00	001 002 020020 20 00
Ambalaj Şekli	Packing Type	Kutu - Box	Kutu - Box
Adet / m	Quantity / m	156 m	156 m
Ağırlık	Weight	19,695 kg	19,695 kg
m ³ /	Volume	0,07636	0,07636

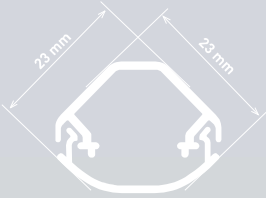

**23x23****Tavan Köşe Kanalı**
Ceiling Corner Trunking**MEKS** Serisi Series

Ürün Kodu	Product Code	001 002 023023 20 00
Ambalaj Şekli	Packing Type	Kutu - Box
Adet / m	Quantity / m	120 m
Ağırlık	Weight	23,940 kg
m ³ /	Volume	0,07636

AKSESUARLAR - ACCESSORIES

Kod Code	Ürün Product	Adet Quantity	Ağırlık Weight	m ³ Volume
 001 041 023023 00 00	T Köşe T Corner	60	0,258 kg	0,00293
 001 042 023023 00 00	90° L Köşe 90° L Corner	60	0,252 kg	0,00293
 001 043 023023 00 00	Ek Parça Connector	100	0,150 kg	0,00131
 001 044 023023 00 00	Uç Tapa Blind Cap	100	0,180 kg	0,00139

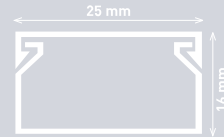
**25x16****EKO** Serisi Series**MEKS** Serisi Series**CANALEX** Serisi Series

Ürün Kodu	Product Code	001 014 025016 20 00	001 002 025016 20 00	001 156 025016 20 00
Ambalaj Şekli	Packing Type	Kutu - Box	Kutu - Box	Kutu - Box
Adet / m	Quantity / m	150 m	150 m	150 m
Ağırlık	Weight	20,505 kg	20,660 kg	18,110 kg
m ³ /	Volume	0,07636	0,07636	0,07636

AKSESUARLAR - ACCESSORIES

Kod Code	Ürün Product	Adet Quantity	Ağırlık Weight	m ³ Volume
 001 039 025016 00 00	İç Köşe Internal Corner	40	0,390 kg	0,00293
 001 040 025016 00 00	Dış Köşe External Corner	40	0,484 kg	0,00293
 001 041 025016 00 00	T Köşe T Corner	30	0,720 kg	0,00364
 001 042 025016 00 00	90° L Köşe 90° L Corner	80	0,490 kg	0,00293
 001 043 025016 00 00	Ek Parça Connector	100	0,260 kg	0,00139
 001 044 025016 00 00	Uç Tapa Blind Cap	100	0,240 kg	0,00139
 001 047 017421 00 00	PM Kasası 1 li Socket Assembly Frame Single	12	1,290 kg	0,00600

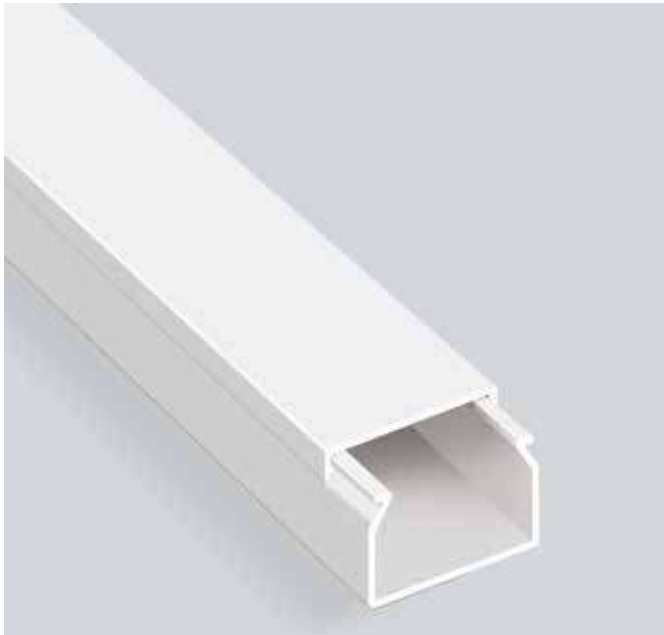

25x25

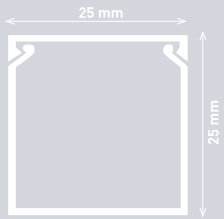

EKO Serisi Series
MEKS Serisi Series
CANALEX Serisi Series

Ürün Kodu	Product Code	001 014 025025 20 00	001 002 025025 20 00	001 156 025025 20 00
Ambalaj Şekli	Packing Type	Kutu - Box	Kutu - Box	Kutu - Box
Adet / m	Quantity / m	100 m	100 m	100 m
Ağırlık	Weight	18,760 kg	18,760 kg	17,360 kg
m ³ /	Volume	0,07636	0,07636	0,07636

AKSESUARLAR - ACCESSORIES

Kod Code	Ürün Product	Adet Quantity	Ağırlık Weight	m ³ Volume
001 039 025025 00 00	İç Köşe Internal Corner	40	0,424 kg	0,00293
001 040 025025 00 00	Dış Köşe External Corner	40	0,516 kg	0,00293
001 041 025025 00 00	T Köşe T Corner	24	0,405 kg	0,00293
001 042 025025 00 00	90° L Köşe 90° L Corner	40	0,516 kg	0,00293
001 043 025025 00 00	Ek Parça Connector	50	0,184 kg	0,00139
001 044 025025 00 00	Uç Tapa Blind Cap	100	0,310 kg	0,00139
001 047 017421 00 00	PM Kasası 1'li Socket Assembly Frame Single	12	1,290 kg	0,00600

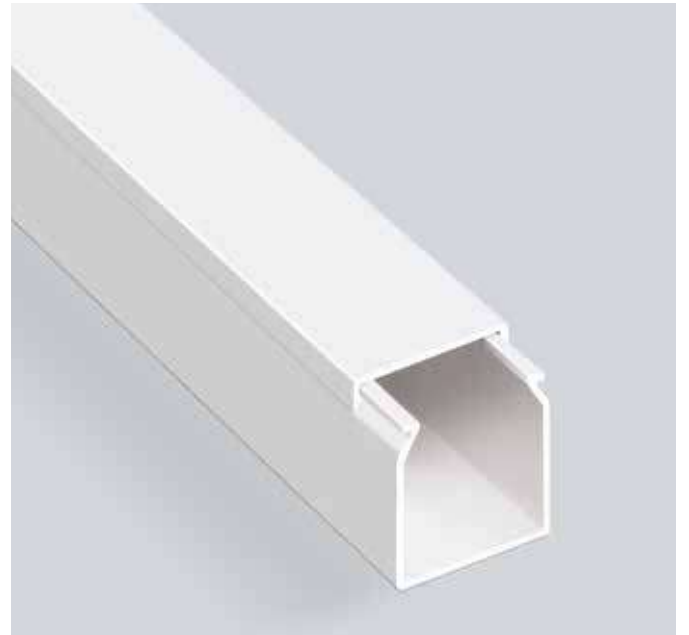

25x40

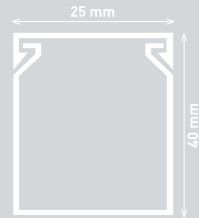

Aksesuarsız
Without Accessories

EKO Serisi Series
MEKS Serisi Series

Ürün Kodu	Product Code	001 014 025040 20 00	001 002 025040 20 00
Ambalaj Şekli	Packing Type	Kutu - Box	Kutu - Box
Adet / m	Quantity / m	80 m	80 m
Ağırlık	Weight	24,843 kg	24,840 kg
m ³ /	Volume	0,07636	0,07636

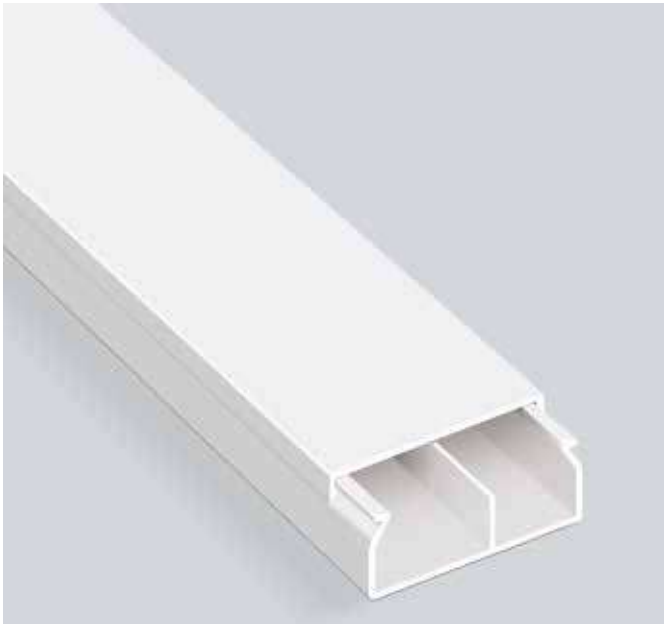

**30x10****Bölmeli**
Partitioned

		EKO <small>Serisi Series</small>	MEKS <small>Serisi Series</small>
Ürün Kodu	Product Code	001 014 930010 20 00	001 002 930010 20 00
Ambalaj Şekli	Packing Type	Kutu - Box	Kutu - Box
Adet / m	Quantity / m	140 m	140 m
Ağırlık	Weight	18,410 kg	18,410 kg
m ³ /	Volume	0,05090	0,05090

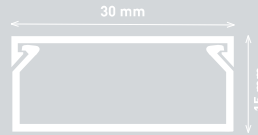
**30x15****Aksesuarsız**
Without Accessories

		EKO <small>Serisi Series</small>	MEKS <small>Serisi Series</small>
Ürün Kodu	Product Code	001 014 030015 20 00	001 002 030015 20 00
Ambalaj Şekli	Packing Type	Kutu - Box	Kutu - Box
Adet / m	Quantity / m	140 m	140 m
Ağırlık	Weight	21,000 kg	21,000 kg
m ³ /	Volume	0,07636	0,07636

AKSESUARLAR - ACCESSORIES

	Kod Code	Ürün Product	Adet Quantity	Ağırlık Weight	m ³ Volume
	001 039 030010 00 00	İç Köşe Internal Corner	50	0,425 kg	0,00293
	001 040 030010 00 00	Dış Köşe External Corner	50	0,490 kg	0,00293
	001 041 030010 00 00	T Köşe T Corner	50	0,595 kg	0,00293
	001 042 030010 00 00	90° L Köşe 90° L Corner	50	0,441 kg	0,00295
	001 043 030025 00 00	Ek Parça Connector	100	0,340 kg	0,00293
	001 044 030025 00 00	Uç Tapa Blind Cap	100	0,405 kg	0,00140





30x16

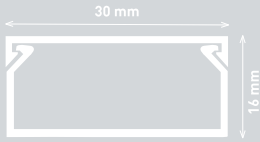

		EKO Seri Series	MEKS Seri Series	CANALEX Seri Series
Ürün Kodu	Product Code	001 014 030016 20 00	001 002 030016 20 00	001 156 030016 20 00
Ambalaj Şekli	Packing Type	Kutu - Box	Kutu - Box	Kutu - Box
Adet / m	Quantity / m	140 m	140 m	140 m
Ağırlık	Weight	23,282 kg	22,862 kg	20,720 kg
m ³ /	Volume	0,07636	0,07636	0,07636

AKSESUARLAR - ACCESSORIES

Kod Code	Ürün Product	Adet Quantity	Ağırlık Weight	m ³ Volume
001 039 030016 00 00	İç Köşe Internal Corner	35	0,380 kg	0,00293
001 040 030016 00 00	Dış Köşe External Corner	48	0,605 kg	0,00293
001 041 030016 00 00	T Köşe T Corner	40	0,565 kg	0,00293
001 042 030016 00 00	90° L Köşe 90° L Corner	50	0,535 kg	0,00293
001 043 030025 00 00	Ek Parça Connector	100	0,340 kg	0,00293
001 044 030025 00 00	Uç Tapa Blind Cap	100	0,405 kg	0,00140
001 047 017421 00 00	PM Kasası 1'li Socket Assembly Frame Single	12	1,290 kg	0,00600

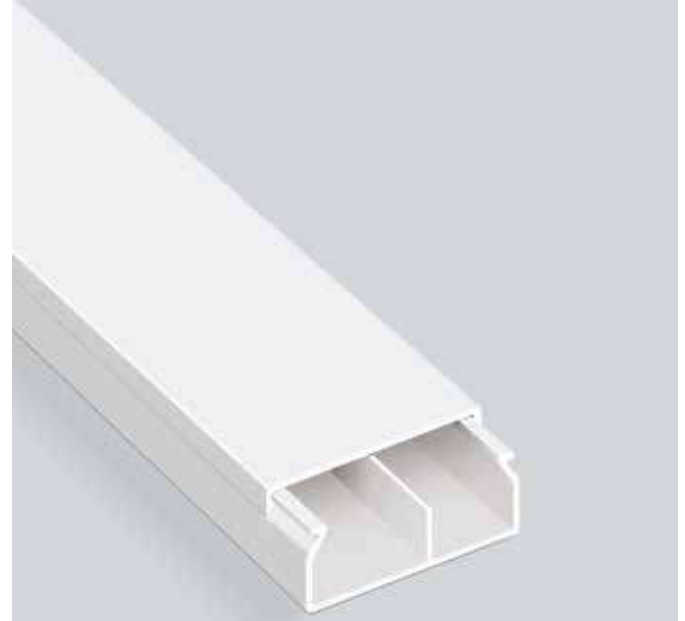

30x16

Bölmeli
Partitioned

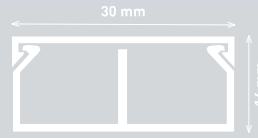

		EKO Seri Series	MEKS Seri Series
Ürün Kodu	Product Code	001 014 930016 20 00	001 002 930016 20 00
Ambalaj Şekli	Packing Type	Kutu - Box	Kutu - Box
Adet / m	Quantity / m	140 m	140 m
Ağırlık	Weight	22,860 kg	22,860 kg
m ³ /	Volume	0,07636	0,07636

AKSESUARLAR - ACCESSORIES

Kod Code	Ürün Product	Adet Quantity	Ağırlık Weight	m ³ Volume
001 039 030016 00 00	İç Köşe Internal Corner	35	0,380 kg	0,00293
001 040 030016 00 00	Dış Köşe External Corner	48	0,605 kg	0,00293
001 041 030016 00 00	T Köşe T Corner	40	0,565 kg	0,00293
001 042 030016 00 00	90° L Köşe 90° L Corner	50	0,535 kg	0,00293
001 043 030025 00 00	Ek Parça Connector	100	0,340 kg	0,00293
001 044 030025 00 00	Uç Tapa Blind Cap	100	0,405 kg	0,00140
001 047 017421 00 00	PM Kasası 1'li Socket Assembly Frame Single	12	1,290 kg	0,00600



30x25

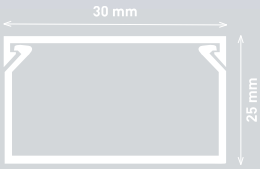

		EKO <small>Serial Series</small>	MEKS <small>Serial Series</small>
Ürün Kodu	Product Code	001 014 030025 20 00	001 002 030025 20 00
Ambalaj Şekli	Packing Type	Kutu - Box	Kutu - Box
Adet / m	Quantity / m	80 m	80 m
Ağırlık	Weight	15,860 kg	15,860 kg
m ³ /	Volume	0,07636	0,07636

AKSESUARLAR - ACCESSORIES

	Kod Code	Ürün Product	Adet Quantity	Ağırlık Weight	m ³ Volume
	001 039 030025 00 00	İç Köşe Internal Corner	32	0,470 kg	0,00293
	001 040 030025 00 00	Dış Köşe External Corner	30	0,530 kg	0,00293
	001 041 030025 00 00	T Köşe T Corner	24	0,445 kg	0,00293
	001 042 030025 00 00	90° L Köşe 90° L Corner	30	0,430 kg	0,00293
	001 043 030025 00 00	Ek Parça Connector	100	0,340 kg	0,00293
	001 044 030025 00 00	Uç Tapa Blind Cap	100	0,405 kg	0,00140
	001 047 017421 00 00	PM Kasası 1'li Socket Assembly Frame Single	12	1,290 kg	0,00600

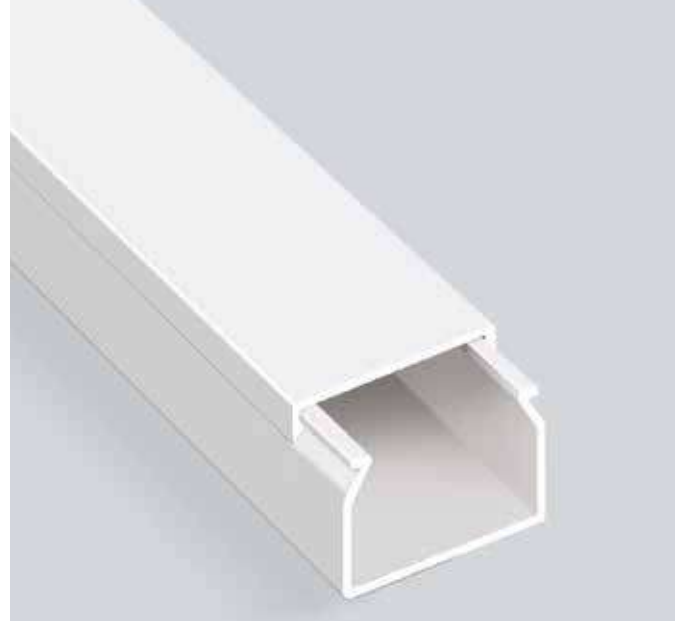

30x30

Aksesuarsız
Without Accessories

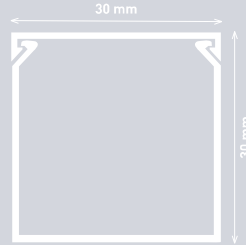

		EKO <small>Serial Series</small>	MEKS <small>Serial Series</small>
Ürün Kodu	Product Code	001 014 030030 20 00	001 002 030030 20 00
Ambalaj Şekli	Packing Type	Kutu - Box	Kutu - Box
Adet / m	Quantity / m	80 m	80 m
Ağırlık	Weight	16,480 kg	16,480 kg
m ³ /	Volume	0,09272	0,09272





40x16

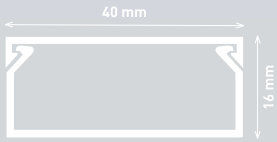

		EKO Sensis Series	MEKS Sensis Series	CANALEX Sensis Series
Ürün Kodu	Product Code	001 014 040016 20 00	001 002 040016 20 00	001 156 040016 20 00
Ambalaj Şekli	Packing Type	Kutu - Box	Kutu - Box	Kutu - Box
Adet / m	Quantity / m	100 m	100 m	100 m
Ağırlık	Weight	18,900 kg	18,900 kg	17,660 kg
m ³ /	Volume	0,07636	0,07636	0,07636

AKSESUARLAR - ACCESSORIES

	Kod Code	Ürün Product	Adet Quantity	Ağırlık Weight	m ³ Volume
	001 039 040016 00 00	İç Köşe Internal Corner	32	0,432 kg	0,00293
	001 040 040016 00 00	Dış Köşe External Corner	30	0,519 kg	0,00293
	001 041 040016 00 00	T Köşe T Corner	24	0,461 kg	0,00293
	001 042 040016 00 00	90° L Köşe 90° L Corner	34	0,524 kg	0,00293
	001 043 040040 00 00	Ek Parça Connector	100	0,753 kg	0,00937
	001 044 040040 00 00	Uç Tapa Blind Cap	50	0,200 kg	0,00182
	001 047 017421 00 00	PM Kasası 1'li Socket Assembly Frame Single	12	1,290 kg	0,00600



40x16

Bölmeli
Partitioned

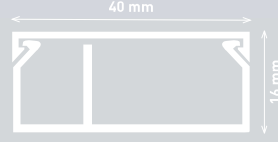

		EKO Sensis Series	MEKS Sensis Series
Ürün Kodu	Product Code	001 014 940016 20 00	001 002 940016 20 00
Ambalaj Şekli	Packing Type	Kutu - Box	Kutu - Box
Adet / m	Quantity / m	100 m	100 m
Ağırlık	Weight	23,160 kg	23,160 kg
m ³ /	Volume	0,07636	0,07636

AKSESUARLAR - ACCESSORIES

	Kod Code	Ürün Product	Adet Quantity	Ağırlık Weight	m ³ Volume
	001 039 040016 00 00	İç Köşe Internal Corner	32	0,432 kg	0,00293
	001 040 040016 00 00	Dış Köşe External Corner	30	0,519 kg	0,00293
	001 041 040016 00 00	T Köşe T Corner	24	0,461 kg	0,00293
	001 042 040016 00 00	90° L Köşe 90° L Corner	34	0,524 kg	0,00293
	001 043 040040 00 00	Ek Parça Connector	100	0,753 kg	0,00937
	001 044 040040 00 00	Uç Tapa Blind Cap	25	0,210 kg	0,00139
	001 047 017421 00 00	PM Kasası 1'li Socket Assembly Frame Single	12	1,290 kg	0,00600

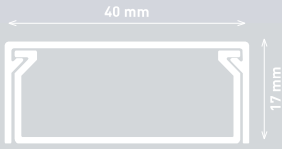
**40x17****Tam Kapaklı - Full Cover**
Aksesuarsız - Without Accessories**MEKS** Serial Series

Ürün Kodu	Product Code	001 002 040017 20 00
Ambalaj Şekli	Packing Type	Kutu - Box
Adet / m	Quantity / m	100 m
Ağırlık	Weight	26,160 kg
m ³ /	Volume	0,07636

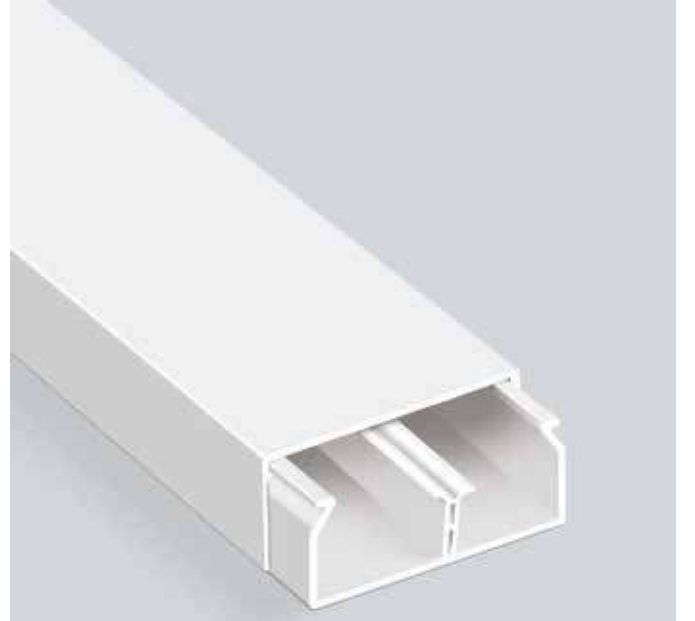
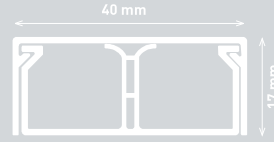
**40x17****Tam Kapaklı Bölmeli**
Full Cover and Partitioned
Aksesuarsız
Without Accessories**MEKS** Serial Series

Ürün Kodu	Product Code	001 002 940017 20 00
Ambalaj Şekli	Packing Type	Kutu - Box
Adet / m	Quantity / m	100 m
Ağırlık	Weight	28,300 kg
m ³ /	Volume	0,07636



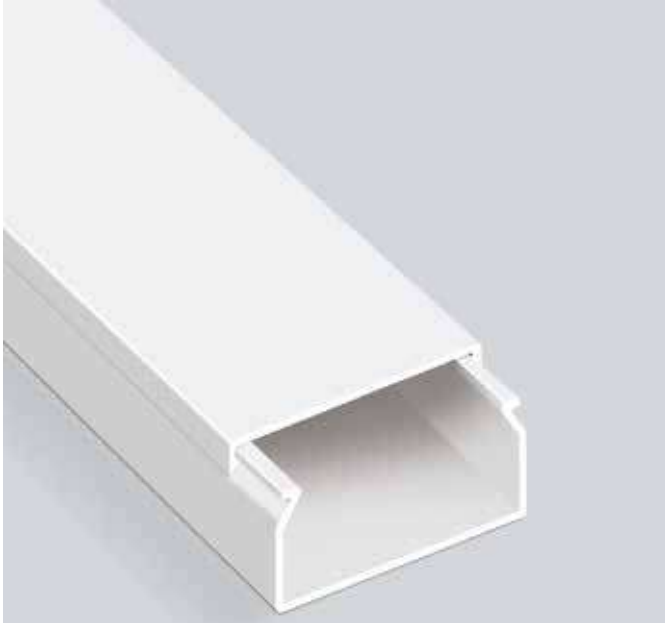

40x25



		EKO Seri Si Series	MEKS Seri Si Series	CANALEX Seri Si Series
Ürün Kodu	Product Code	001 014 040025 20 00	001 002 040025 20 00	001 156 040025 20 00
Ambalaj Şekli	Packing Type	Kutu - Box	Kutu - Box	Kutu - Box
Adet / m	Quantity / m	80 m	80 m	80 m
Ağırlık	Weight	19,640 kg	18,840 kg	17,200 kg
m ³ /	Volume	0,09272	0,09272	0,09272

AKSESUARLAR - ACCESSORIES

Kod Code	Ürün Product	Adet Quantity	Ağırlık Weight	m ³ Volume
001 039 040025 00 00	İç Köşe Internal Corner	24	0,449 kg	0,00293
001 040 040025 00 00	Dış Köşe External Corner	30	0,711 kg	0,00293
001 041 040025 00 00	T Köşe T Corner	18	0,407 kg	0,00293
001 042 040025 00 00	90° L Köşe 90° L Corner	24	0,432 kg	0,00293
001 043 040040 00 00	Ek Parça Connector	100	0,722 kg	0,01011
001 044 040040 00 00	Uç Tapa Blind Cap	50	0,350 kg	0,00182
001 047 017421 00 00	PM Kasası 1'li Socket Assembly Frame Single	12	1,290 kg	0,00600



40x40

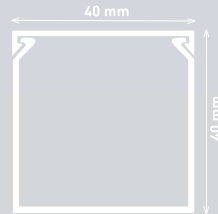

		EKO Seri Si Series	MEKS Seri Si Series	CANALEX Seri Si Series
Ürün Kodu	Product Code	001 014 040040 20 00	001 002 040040 20 00	001 156 040040 20 00
Ambalaj Şekli	Packing Type	Kutu - Box	Kutu - Box	Kutu - Box
Adet / m	Quantity / m	50 m	50 m	50 m
Ağırlık	Weight	15,500 kg	15,500 kg	14,150 kg
m ³ /	Volume	0,09272	0,09272	0,09272

AKSESUARLAR - ACCESSORIES

Kod Code	Ürün Product	Adet Quantity	Ağırlık Weight	m ³ Volume
001 039 040040 01 00	Hareketli İç Köşe Internal Corner Live	18	0,540 kg	0,00289
001 040 040040 01 00	Hareketli Dış Köşe External Corner Live	16	0,496 kg	0,00289
001 041 040040 00 00	T Köşe T Corner	48	1,415 kg	0,01011
001 042 040040 00 00	90° L Köşe 90° L Corner	60	1,488 kg	0,01011
001 043 040040 00 00	Ek Parça Connector	100	0,800 kg	0,00937
001 044 040040 00 00	Uç Tapa Blind Cap	50	0,350 kg	0,00182

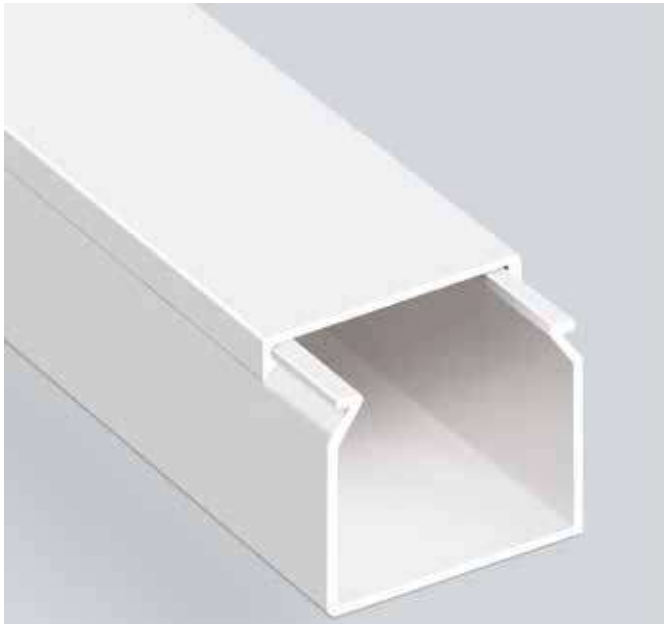
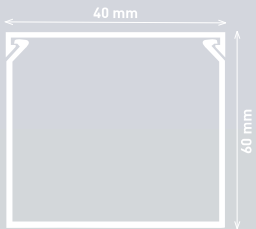
**40x60****Aksesuarsız**
Without Accessories**EKO** Serisi Series**MEKS** Serisi Series

Ürün Kodu	Product Code	001 014 040060 20 00	001 002 040060 20 00
Ambalaj Şekli	Packing Type	Kutu - Box	Kutu - Box
Adet / m	Quantity / m	40 m	40 m
Ağırlık	Weight	21,518 kg	21,520 kg
m ³ /	Volume	0,11029	0,11029

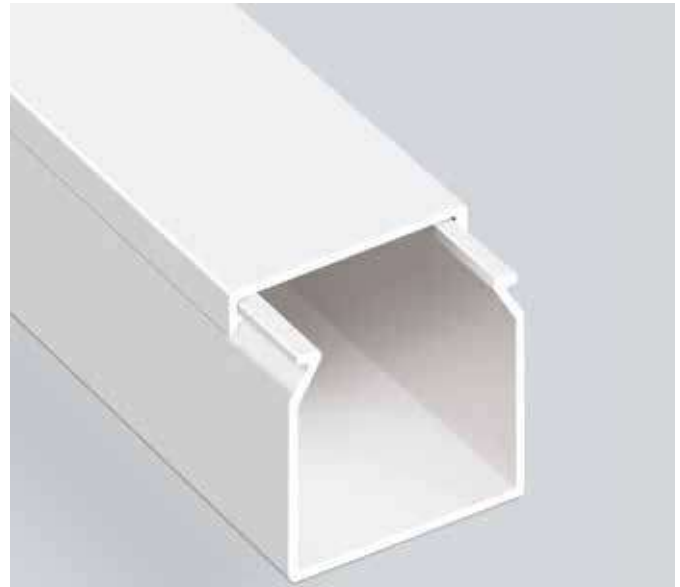
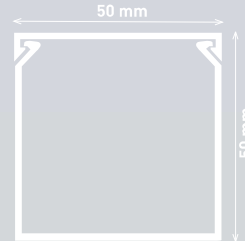
**50x50****Aksesuarsız**
Without Accessories**EKO** Serisi Series

Ürün Kodu	Product Code	001 014 050050 20 00
Ambalaj Şekli	Packing Type	Kutu - Box
Adet / m	Quantity / m	30 m
Ağırlık	Weight	14,052 kg
m ³ /	Volume	0,09272





60x25

Bölmeli
Partitioned



		EKO Seri Si Series	MEKS Seri Si Series
Ürün Kodu	Product Code	001 014 690025 20 00	001 002 690025 20 00
Ambalaj Şekli	Packing Type	Kutu - Box	Kutu - Box
Adet / m	Quantity / m	40 m	40 m
Ağırlık	Weight	17,140 kg	17,140 kg
m ³ /	Volume	0,07636	0,07636

AKSESUARLAR - ACCESSORIES

	Kod Code	Ürün Product	Adet Quantity	Ağırlık Weight	m ³ Volume
	001 039 060025 00 00	İç Köşe Internal Corner	48	1,192 kg	0,01011
	001 040 060025 00 00	Dış Köşe External Corner	72	1,781 kg	0,01011
	001 041 060025 00 00	T Köşe T Corner	40	1,250 kg	0,01011
	001 042 060025 00 00	90° L Köşe 90° L Corner	60	2,190 kg	0,01008
	001 043 060060 00 00	Ek Parça Connector	25	0,372 kg	0,00293
	001 044 060025 00 00	Uç Tapa Blind Cap	50	0,510 kg	0,00293
	001 047 017421 00 00	PM Kasası T'li Socket Assembly Frame Single	12	1,290 kg	0,00600



60x40

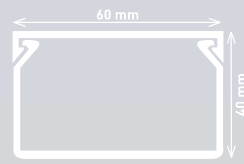

		EKO Seri Si Series	MEKS Seri Si Series	ÇANALEX Seri Si Series
Ürün Kodu	Product Code	001 014 060040 20 00	001 002 060040 20 00	001 156 060040 20 00
Ambalaj Şekli	Packing Type	Kutu - Box	Kutu - Box	Kutu - Box
Adet / m	Quantity / m	40 m	40 m	40 m
Ağırlık	Weight	16,400 kg	16,400 kg	15,518 kg
m ³ /	Volume	0,11029	0,11029	0,11029

AKSESUARLAR - ACCESSORIES

	Kod Code	Ürün Product	Adet Quantity	Ağırlık Weight	m ³ Volume
	001 039 060040 00 00	İç Köşe Internal Corner	26	1,160 kg	0,01011
	001 040 060040 00 00	Dış Köşe External Corner	32	1,225 kg	0,01011
	001 041 060040 00 00	T Köşe T Corner	32	1,180 kg	0,01011
	001 042 060040 00 00	90° L Köşe 90° L Corner	40	1,375 kg	0,01011
	001 043 060060 00 00	Ek Parça Connector	25	0,372 kg	0,00293
	001 044 060040 00 00	Uç Tapa Blind Cap	30	0,975 kg	0,00294

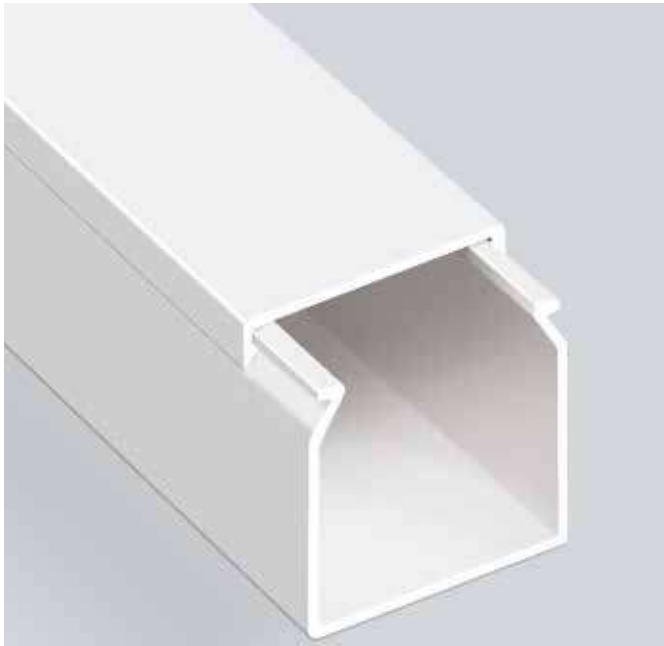

60x60

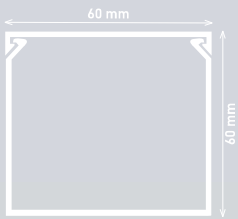

EKO Serisi Series
MEKS Serisi Series
CANALEX Serisi Series

Ürün Kodu	Product Code	001 014 060060 20 00	001 002 060060 20 00	001 156 060060 20 00
Ambalaj Şekli	Packing Type	Kutu - Box	Kutu - Box	Kutu - Box
Adet / m	Quantity / m	32 m	32 m	32 m
Ağırlık	Weight	20,445 kg	20,445 kg	18,717 kg
m ³ /	Volume	0,13392	0,13392	0,13392

AKSESUARLAR - ACCESSORIES

Kod Code	Ürün Product	Adet Quantity	Ağırlık Weight	m ³ Volume
 001 039 060060 01 00	Hareketli İç Köşe Internal Corner Live	16	1,123 kg	0,01011
 001 040 060060 01 00	Hareketli Dış Köşe External Corner Live	16	1,361 kg	0,01011
 001 041 060060 00 00	T Köşe T Corner	20	1,406 kg	0,01011
 001 042 060060 00 00	90° L Köşe 90° L Corner	24	1,691 kg	0,01011
 001 043 060060 00 00	Ek Parça Connector	25	0,372 kg	0,00293
 001 044 060060 00 00	Uç Tapa Blind Cap	30	0,975 kg	0,00294

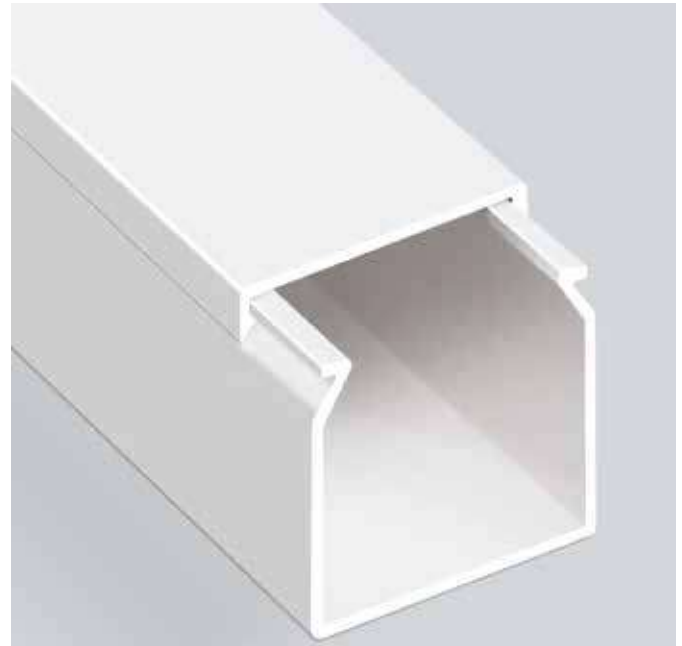

75x75

Aksesuarsız
Without Accessories

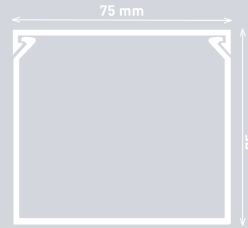

EKO Serisi Series

Ürün Kodu	Product Code	001 014 075075 20 00
Ambalaj Şekli	Packing Type	Kutu - Box
Adet / m	Quantity / m	28 m
Ağırlık	Weight	25,153 kg
m ³ /	Volume	0,13392





80x40



		EKO Seri Series	MEKS Seri Series	CANALEX Seri Series
Ürün Kodu	Product Code	001 014 080040 20 00	001 002 080040 20 00	001 156 080040 20 00
Ambalaj Şekli	Packing Type	Kutu - Box	Kutu - Box	Kutu - Box
Adet / m	Quantity / m	30 m	30 m	30 m
Ağırlık	Weight	19,518 kg	19,518 kg	17,118 kg
m ³ /	Volume	0,11029	0,11029	0,11029

AKSESUARLAR - ACCESSORIES

	Kod Code	Ürün Product	Adet Quantity	Ağırlık Weight	m ³ Volume
	001 039 080040 00 00	İç Köşe Internal Corner	18	1,107 kg	0,01011
	001 040 080040 00 00	Dış Köşe External Corner	8	0,839 kg	0,00653
	001 041 080040 00 00	T Köşe T Corner	12	1,194 kg	0,01011
	001 042 080040 00 00	90° L Köşe 90° L Corner	16	1,386 kg	0,01011
	001 043 080040 00 00	Ek Parça Connector	100	1,200 kg	0,00937
	001 044 080040 00 00	Uç Tapa Blind Cap	60	0,887 kg	0,00293

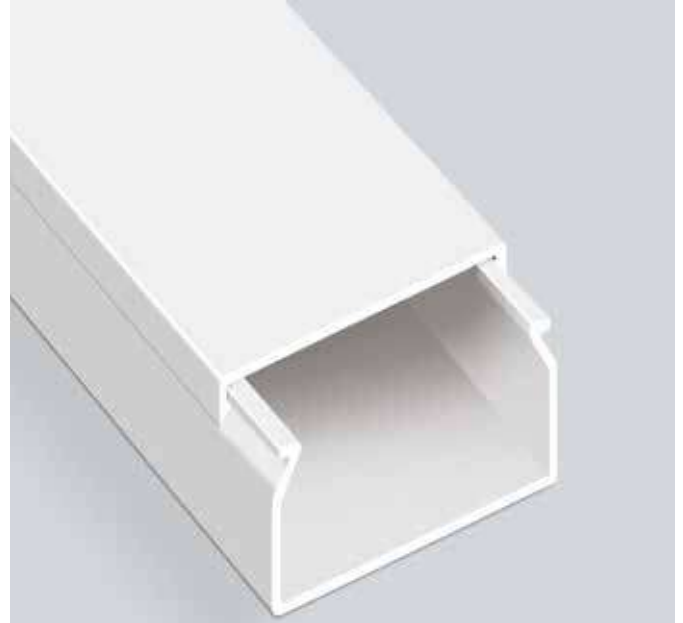

80x60



		EKO Seri Series	MEKS Seri Series	CANALEX Seri Series
Ürün Kodu	Product Code	001 014 080060 20 00	001 002 080060 20 00	001 156 080060 20 00
Ambalaj Şekli	Packing Type	Kutu - Box	Kutu - Box	Kutu - Box
Adet / m	Quantity / m	24 m	24 m	24 m
Ağırlık	Weight	17,232 kg	17,232 kg	16,157 kg
m ³ /	Volume	0,13392	0,13392	0,13392

AKSESUARLAR - ACCESSORIES

	Kod Code	Ürün Product	Adet Quantity	Ağırlık Weight	m ³ Volume
	001 039 080060 00 00	İç Köşe Internal Corner	12	0,980 kg	0,01011
	001 040 080060 00 00	Dış Köşe External Corner	8	0,898 kg	0,00653
	001 041 080060 00 00	T Köşe T Corner	10	1,237 kg	0,01011
	001 042 080060 00 00	90° L Köşe 90° L Corner	12	1,287 kg	0,01010
	001 043 080060 00 00	Ek Parça Connector	80	1,120 kg	0,00937
	001 044 080060 00 00	Uç Tapa Blind Cap	48	0,944 kg	0,00293

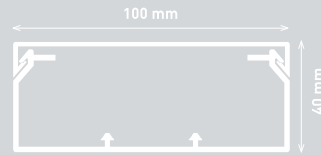
**100x40****Kilitleme Aparatı**
With Locking Apparatus

		EKO Seri Series	MEKS Seri Series	CANALEX Seri Series
Ürün Kodu	Product Code	001 014 100040 20 00	001 002 100040 20 00	001 156 100040 20 00
Ambalaj Şekli	Packing Type	Kutu - Box	Kutu - Box	Kutu - Box
Adet / m	Quantity / m	24 m	24 m	24 m
Ağırlık	Weight	18,648 kg	21,918 kg	16,380 kg
m ³ /	Volume	0,11029	0,11029	0,11029

AKSESUARLAR - ACCESSORIES

	Kod Code	Ürün Product	Adet Quantity	Ağırlık Weight	m ³ Volume
	001 013 100040 20 00	Ara Bölme Partition	200 m	21,050 kg	0,05040
	001 039 100040 00 00	İç Köşe Internal Corner	8	0,795 kg	0,01011
	001 039 100040 01 00	İç Köşe Hareketli Internal Corner Live	10	1,651 kg	0,01312
	001 040 100040 00 00	Dış Köşe External Corner	8	0,905 kg	0,00653
	001 040 100040 01 00	Dış Köşe Hareketli External Corner Live	10	0,959 kg	0,00817
	001 041 100040 00 00	T Köşe T Corner	12	1,344 kg	0,01010
	001 042 100040 00 00	90° L Köşe 90° L Corner	12	1,233 kg	0,01011
	001 043 100060 00 00	Ek Parça Connector	100	0,966 kg	0,01011
	001 044 100060 00 00	Uç Tapa Blind Cap	16	0,396 kg	0,00182
	001 050 030004 00 00	Kilitleme Aparatı Locking Apparatus	100	0,280 kg	0,00100